



---

## TABLE OF CONTENTS

Chapter 1	Introduction	1
<b>Practice Statements and Descriptions</b>		
Chapter 2	Planning and Design	7
Chapter 3	One Call Center	17
Chapter 4	Locating and Marking	33
Chapter 5	Excavation	43
Chapter 6	Mapping	57
Chapter 7	Compliance	63
Chapter 8	Public Education and Awareness	73
Chapter 9	Reporting and Evaluation	81
Chapter 10	Miscellaneous	89
<b>Appendix A</b>	<b>Glossary of Terms and Definitions</b>	<b>91</b>
<b>Appendix B</b>	<b>Uniform Color Code and Marking Guidelines</b>	<b>95</b>
<b>Appendix C</b>	<b>Sample Forms, Reports, and Releases</b>	<b>107</b>
<b>Appendix D</b>	<b>Additional References and Endnotes</b>	<b>111</b>
	<b>CGA Member Organizations</b>	<b>115</b>

## TERMS AND CONDITIONS OF USE

The CGA must make the Best Practices subject to the following limitations:

- 1: The CGA does not endorse any company, technology, technique or product. No inference of endorsement shall be taken from any CGA Best Practice or from the CGA generally.
- 2: The CGA reserves the right to alter, modify, or repeal the Best Practices at any time. Further, the CGA reserves the right to fix technical inaccuracies, typographical errors or make other modifications without prior notice.
- 3: The Best Practices may contain trademarks of the CGA, as well as CGA copyrighted material. We must insist you respect our copyrights and trademarks.
- 4: The CGA Best Practices are provided “AS IS” and without any WARRANTY, EITHER EXPRESSED OR IMPLIED, INCLUDING ANY WARRANTY OF MERCHANTABILITY FITNESS FOR A PARTICULAR PURPOSE, OR NON-INFRINGEMENT.
- 5: The CGA Best Practices are presented as a general guide. The CGA encourages all users to consult and consider not only the CGA Best Practices, but also (i) employer practices, (ii) industry practices, (iii) federal and state statutes and regulations, (iv) building and fire codes, and (v) local laws, regulations and ordinances.
- 6: References in each Best Practice are those that were in effect at the time the Best Practice was approved unless otherwise noted. Best Practices are derived from existing multi-industry, governmental and public practices that are determined to be “best” in enhancing safety and damage prevention through rigorous review and evaluation processes developed by the CGA.

# CHAPTER 1

## Introduction

### Best Practices Manual

The Best Practices Guide is the preeminent and trusted resource for underground damage prevention with more than 160 practices that cover all phases of the safe digging process. The practices included within this guide are agreed to by consensus of 16 industry stakeholder groups and are designed to improve worker safety, protect vital underground infrastructure, and ensure public safety during excavation activities conducted in the vicinity of existing underground facilities.

CGA releases a new edition of Best Practices every spring with all approved updates that reflect changes in damage prevention.

### Best Practices 17.0 — New Practices and Modifications

During 2019, the CGA added and amended practices that appear in Version 17.0. The following new practices and definitions were approved by the Best Practices Committee and CGA Board in 2019:

- New Practice 2-18, *Identifying newly installed or under construction facilities*
- New Practice 3-32, *Communicate potential for privately-owned facilities*
- New Practice 8-11, *Cross bore determination and mitigation*
- New Glossary Definition, *Cross Bore*
- New Glossary Definition, *Private Service Line*

A review of all changes to the Best Practices can also be viewed at <http://commongroundalliance.com/best-practices-guide>.

## History of the Common Ground Alliance

### Common Ground Study

In 1998, the U.S. Congress passed the Transportation Equity Act for the 21st Century (TEA 21). In this legislation, the U.S. Department of Transportation (USDOT) was instructed to conduct a study of best practices in place nationwide for enhancing worker safety, protecting vital underground infrastructure, and ensuring public safety during excavation activities conducted in the vicinity of existing underground facilities.

The USDOT's Pipeline and Hazardous Materials Safety Administration (PHMSA) convened a meeting of stakeholders from underground utility safety and damage prevention industries. Each major stakeholder group designated representatives to participate in the study.

In all, 162 individuals participated in the study, representing stakeholders from across the nation, including oil and gas transmission and distribution, telecommunications, railroads, utilities, electric, water, sewer, cable TV, one call centers, excavators, locators, design engineers, regulators, and government entities at federal, state, and local levels.

One of the most controversial elements of the process for determining a “best practice” was the use of the consensus process. For a practice to become a “best practice,” all stakeholder groups had to agree that they could live with the practice; if one group disagreed, the practice would not become a “best practice.” To this day, consensus is used by CGA committees and in identifying “best practices.”

The Common Ground Study identified and validated over 130 best practices to enhance safety and prevent damages to underground facilities. In July 1999, 11 months after the kick-off meeting, the study was presented to the Secretary of Transportation.

## **Establishment of the Common Ground Alliance**

After the Common Ground Study was presented to the Secretary of Transportation, PHMSA was asked to facilitate and sponsor what became known as the Damage Prevention Path Forward. On June 15, 2000, the work of the team was completed when the Common Ground Alliance received its Certificate of Incorporation from the District of Columbia.

When established, the Common Ground Alliance identified the following purposes:

- Prevent damage to underground infrastructure and increase safety by fostering a sense of shared responsibility for the protection of underground facilities
- Support research and development
- Conduct public awareness and education programs
- Identify and disseminate stakeholder best practices
- Serve as a clearinghouse for damage data collection analysis and dissemination

The organization's motto was and continues to be "Damage Prevention Is a Shared Responsibility."

## **CGA Today**

In line with CGA's founding philosophy, the current CGA mission is to "prevent damage to underground utility infrastructure and protect those who live and work near these important assets through the shared responsibility of our stakeholders."

There are currently 16 stakeholder groups participating in the CGA: electric, engineering/design, equipment manufacturing, excavator, gas transmission, gas distribution, insurance, locator, one call center, oil, public works, railroad, road builder, state regulator, emergency services, and telecommunications.

The CGA consists of working committees populated by the general membership. The committees include Best Practices, Technology, Educational Programs, Data Reporting and Evaluation, Regional Partner, Stakeholder Advocacy Committee, and One Call Systems International.

Even though any CGA member can participate in committee discussions, a "Primary" is designated for each stakeholder group by its respective member on the Board of Directors. The Primary's responsibility is to act as a spokesperson for their stakeholder group and to participate in consensus decisions when necessary. This ensures that each stakeholder group has an equal say in the outcome of committee work, decisions, and products.

The Best Practices document continues to be the "go to" resource by all stakeholders, governments, and associated industries when addressing safety and damage prevention issues internally, as well as on the local, state, and national levels.

## Best Practices Document

The Best Practices Committee developed the following guide based on the Common Ground Study, which includes the primary section with Practice Statements and Descriptions as well as Appendices A through D. The verbatim restatement of all ancillary material contained in the original Study is available on the CGA Web site and is intended as an historical reference point for those persons interested in a more detailed background of the Best Practices.

The stakeholders involved with the original study never intended that the Best Practices would constitute a static model. Rather, they intended it to be a working document that would evolve over time as more was learned and as technology advanced. In addition, the CGA anticipated that there likely would be additional best practices developed by the interested participants. As best practices are added or amended, the changes are reflected in subsequent versions, numbered sequentially.

### Use of Icons

The CGA uses icons to assist readers in identifying the practices that pertain to their specific industry/stakeholder group. Throughout the document, the icons appear next to each practice and correspond to the following groups: Project Owners, Facility Owners, Excavators, One Call Centers, Designers, and Locators. The icon legend is provided below and also is available at the start of each chapter.



### Guide to Editorial Task Team Procedures

- 1: The Editorial Task Team is a task force of the Best Practices (BP) Committee. As such it acts in accordance with the BP Committee's instructions.
- 2: Although the team may edit punctuation, grammar, organization, and display, the team does not make substantive changes to best practices or best practice descriptions. However, any editorial changes are reported back to the BP Committee for review and comment.
- 3: The team receives input from the BP Committee in one of three ways:
  - a) When it receives a best practice that has been adopted
  - b) When it is instructed by the BP Committee to make non-substantive changes to the BP practice description
  - c) When it makes the changes indicated in paragraph 2 above, presents them to the BP Committee, and receives feedback thereafter
- 4: Editorial changes noted in paragraph 3b are only those that the BP Committee first determines are not substantive alterations to the best practice. They are handled in the same manner as a best practice, in that BP Committee members must agree by consensus, but they are not referred to the CGA board for adoption, as would be the case for a new or amended best practice.
- 5: Allen Gray and William Boswell serve as the Editorial Task Team leaders.

### Feedback and Proposed Modifications

The CGA welcomes comments and suggestions on improving the format and updating the content of the best practices. Our intent is to make the statement of best practices as easy to use as possible. To submit a comment or to propose a new practice or practice modification, contact the CGA office (703-836-1709) to request a proposal form or visit the CGA Web site at <http://www.commongroundalliance.com>.

## Best Practices Process

### How Is a Best Practice Developed or Revised?

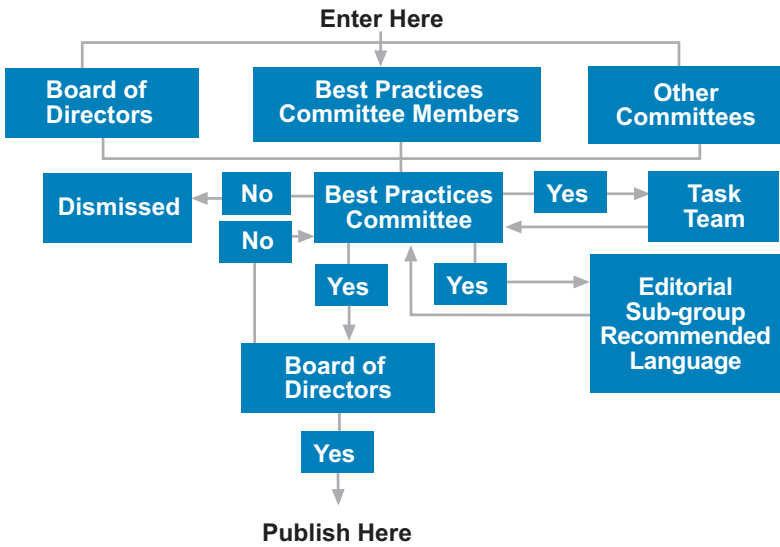

Anyone can submit a proposed best practice for review, either through their stakeholder group primary or directly to CGA staff. The Board of Directors as well as other CGA Committees may also submit proposed Best Practices.



The proposed Best Practice is brought before the next scheduled meeting of the Committee. This enables Committee members and their stakeholder group to review the proposal for discussion. The Committee reviews and discusses the proposal and decides whether it will be dismissed or considered for Best Practices designation. If the Committee agrees to consider the practice, a task team is formed and a transaction record is created.



The Task Team forwards the proposed Best Practice to the full Committee for consideration. In order to give each stakeholder group an opportunity to review the proposal, the Task Team must submit the proposed Best Practice at least 30 days before the next scheduled meeting. However, the Task Team is encouraged to submit as soon as possible for review by the full Committee. Each Stakeholder Primary is responsible for taking the proposal to their respective constituent group for review and position development. Each stakeholder group is asked to submit any questions, comments, concerns they may have with the proposed Best Practice before the next scheduled meeting convenes.



During the next scheduled meeting, the Task Team presents the proposed practice, which is comprehensively reviewed and discussed. The Committee decides whether the proposal is presented to the Board as a proposed Best Practice or whether it should go back to the Task Team for further consideration. It is not unusual for the practice to be sent back to the Task Team.



A task team is created using volunteers from the full Best Practices Committee, and a team chair is appointed. A cross-section of stakeholders is recommended for each task team to ensure input from as many stakeholder groups as possible.

A Transaction Record (TR) is created to track progress of the proposal from submission to the Task Team to the final decision on the proposed practice. The TR is numbered according to the year it is submitted to the Task Team (e.g., TR 2011), and a chronological acceptance for consideration during the year (i.e., if it was the first to be accepted, it would be numbered TR 2011-01, second TR 2011-02, and so on).

If the Committee reaches consensus approval of the wording, the Best Practice is forwarded to the Editorial Task Team. The Editorial Task team decides on the appropriate placement of the practice within the CGA Best Practices document and ensures that the language is consistent with Best Practice Committee protocols.

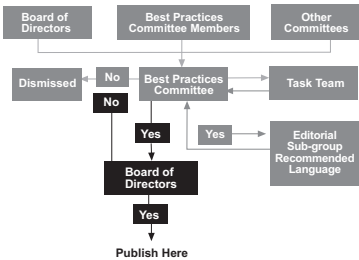

The final proposed Best Practice is then submitted to the Board of Directors for their consideration. If approved, the practice becomes a CGA Best Practice and is published in the manual. If not, the proposal is sent back to the Committee with comment.

If returned to the Committee, the proposal is reviewed (taking into account the Board's comments) and resubmitted as appropriate.

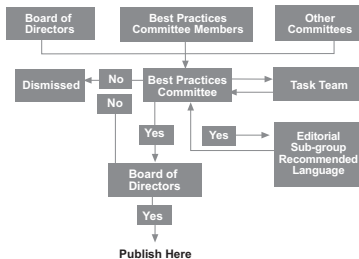

Once a Best Practice has been published, all stakeholders can rest assured it has been through the complete process.

The process ensures the integrity of Best Practices and their place in enhancing safety and keeping damaged to an ultimate minimum.

The Best Practice proposals can be submitted through the CGA Web site. Visit the online version of Best Practices at <http://www.commongroundalliance.com/best-practices-guide> to view the new practice proposal form.



LEFT BLANK INTENTIONALLY

## Planning and Design



One Call Center



Facility Owner



Excavator



Locator



Project Owner



Designer

### 2-1: Plat Designation of Existing Underground Facility Easements



**Practice Statement:** Plats prepared for the development of real property identify and show the alignment of any existing buried facilities and the presence and extent of any existing easements and/or rights of way.<sup>18/</sup>

**Practice Description:** Various items are required on the plats filed prior to the development of lands. Where plats are required to be filed, the items required include the identification of the easements of underground facilities traversing the land described on the plat. Identifying easements of underground facilities on the plat increases notice to developers and the public about the existence of the underground facilities. Notifying owners of underground facilities that a plat has been filed alerts underground facility owners/operators of the need to establish communication between the developers and operators that will facilitate a plan and design for the use of the land that complements the underground facility.

**Benefits:**

Often underground facility owners/operators do not receive notice of developments impacting their facilities until excavation activity has commenced. This compromises the optimal use of the land and potentially compromises the integrity of the underground facility.

**References:**

- St Louis County, Minnesota, zoning ordinances

### 2-2: Gathering Information for Design Purposes



**Practice Statement:** The designer uses all reasonable means of obtaining information about underground facilities in the area of the planned excavation.

**Practice Description:** During the planning phase of the project, all available information is gathered from facility owners/operators. This includes maps of existing, abandoned, and out-of-service facilities; cathodic protection and grounding systems; as-builts of facilities in the area if the maps are not current; proposed project designs; and schedules of other work in the area. This information is gathered for the purpose of route selection and preliminary neighborhood impacts and as part of the process of impact analysis when evaluating different design possibilities. Methods of gathering information may include contacting entities such as a one call center, facility owners/operators, coordinating committees/councils, other designers, engineering societies, and governmental agencies to help identify underground facility owners/operators in an excavation area. Gathering information also may include a review of the site for aboveground indications of underground facilities (e.g., permanent signs or markers, manhole covers, vent pipes, pad-mounted devices, riser poles, power and communication pedestals, and valve covers). The one call center provides a listing of operators directly to the designer or to the designer's subsurface utility engineer. This information is made available in formats that are accessible to all users, such as voice, fax, e-mail, or Web site. Once the operators are identified, the designer contacts the operators directly or uses the one call system. The facility owner/operator may locate the underground facilities or provide locations of the underground facilities to the designer by other means, such as by marking up design drawings or providing facility records to the designer.

**Benefits:**

- Gathering underground facility information and including this information in the planning phase minimizes the hazards, cost, and work to produce the final project.
- Safety is enhanced.
- Unexpected conflicts with facilities are eliminated.
- Facility relocations are minimized.

**References:**

- Wisconsin Sec. 186.0175 Stats
- Minnesota Statute 216D
- Pennsylvania Act 287 of 1974, as amended by Act 187 of 1996
- See related Finding Number 3, “Identifying Existing Facilities in Planning and Design”
- “Construction Management Interference Control Manual,” Consolidated Edison, New York, New York, June 9, 1997
- Subsurface Utility Engineering, Federal Highway Administration (FHWA), February 1999, Office of Program Administration
- Florida Department of Transportation Utility Accommodation Manual, Document No. 710-020-001-d, Section 11.4, January 1999

**2–3: Identifying Existing Facilities in Planning and Design**



**Practice Statement:** Designers indicate existing underground facilities on drawings during planning and design.

**Practice Description:** During the planning phase of the project, existing facilities are shown on preliminary design plans. The planning documents include possible routes for the project together with known underground facility information. The various facility owners/operators are then given the opportunity to provide appropriate feedback. During the design phase of the project, underground facility information from the planning phase is shown on the plans. If information was gathered from field-located facilities, underground facility surveys, or subsurface utility engineering, this is noted on the plans. The designer and the contractor both know the quality of the information included on the plans. If an elevation was determined during information gathering, it is shown on the plan. The facilities shown include active, abandoned, out-of-service, and proposed facilities. The design plans include a summary drawing showing the proposed facility route or excavation, including streets and a locally accepted coordinate system. The plans are then distributed to the various facility owners/ operators to provide the opportunity to furnish additional information, clarify information, and identify conflicts.

**Benefits:**

Providing complete underground facility information and including this information on design drawings reduces hazards, simplifies coordination, and minimizes the cost to produce the final project.

## 2-4: Utility Coordination



**Practice Statement:** Project owners and facility owners/operators regularly communicate and coordinate with each other concerning future and current projects.

**Practice Description:** Utility coordination fosters an open exchange of information among private and public facilities, governmental agencies, and construction-related organizations. Utility coordination also promotes cooperation among said groups in the planning, design, and construction of projects affecting the overall good of participating parties, their organizations and customers or constituents, and the general public. Utility coordinating committees (or councils) include private utilities, public agency utilities, engineering firms, contractor associations, and others with facilities or business interests in public rights-of-way. Coordinating committees function in multiple communities, counties, and states/provinces to promote excavation project coordination. Typical items of discussion include facility excavations in existing and recently paved roadways, disruption of essential facility services, location of utility facilities, environmental impact of damages to utilities, permit procedures, right-of-way access controls, and underground facility damage prevention. Plans of future roadway improvement and of future facility installations are reviewed regularly.

### References:

- Wisconsin Administrative Rule Chapter Trans 220 “Utility Facilities Relocations”
- Arizona Utility Coordinating Committee (AUCC) Public Improvement/Project Guide, December 1996
- Highway/Utility Guide. Publication No. FHWA-SA-93-049. Office of Technology Applications, FHWA, U.S. Department of Transportation, June 1993.

## 2-5: Markers for Underground Facilities<sup>63/</sup>



**Practice Statement:** The presence and type of underground facilities are indicated by permanent aboveground and belowground markers and material.

**Practice Description:** A combination of aboveground and belowground markers is used to identify and locate underground facilities. The facility is color-coded in accordance with the American Public Works Association (APWA) guidelines to assist in identifying an aboveground or belowground facility.

The purpose of aboveground markers is to identify underground facilities, not to locate for excavation or circumvent the one call process. However, designing underground facilities for future location reduces the risk of an incorrectly marked underground facility during an excavation project. Aboveground markers are developed during the design process and include the company name, type of facility, emergency contact, and the one call number. The locations and types of markers are specified in the construction plans. The design provides a marker system that includes, but is not limited to, stream crossings, public road crossings, other facilities’ rights-of-way, railroad crossings, heavy construction areas, and any other location where it is necessary to identify the underground facility location. If nondetectable facilities are being installed, the design includes a means to accurately locate the underground facility from the surface. Road decals, stencils, tracer tapes, electronic markers, or other appropriate systems may mark areas where traditional markers are considered impractical.

The purpose of belowground markers is to identify underground facilities. Belowground markers are used in conjunction with aboveground markers. Belowground markers may include tracer wire, warning tape, and/or electronic marking devices. More than one type of belowground marker may

be used. Installation of belowground markers should comply with AGA, ANSI, or other industry standards or governing regulations including, but not limited to, using a coated corrosion-resistant wire, installing cathodic protection, proper grounding, marking the end placement or approximate location of belowground markers with aboveground markers, protecting belowground markers from damage during backfill operations, and placement/method of installation.

**Benefits:**

Provisions to aid in future locating requests are included in the design. In addition, an effective marker system is beneficial to the underground facility owner/operator and first responders to an area involving more than one underground facility or an incident near underground facilities.

**References:**

- 49 CFR Parts 192 and 195
- Industry standards:
  - AGA *Plastic Pipe Manual for Gas Service*, 2006 Edition
  - APWA, “Guidelines for Uniform Temporary Marking of Underground Facilities”
  - ANSI ASC GPTC Z380 Gas Piping Technology Guide (<https://www.aga.org/gptc>)
  - NFPA-70 (2014), “National Electrical Code”

**2–6: Follow All Applicable Codes, Statutes, and Facility Owner/Operator Standards**



**Practice Statement:** When planning and designing the installation of new or replacement of existing underground facilities, the designer follows all federal, state/provincial, and local guidelines, codes, statutes, and other facility owner/operator standards.

**Practice Description:** The designer of a facility project typically considers only national industry codes, regulations, and practices applicable to that particular facility and not of adjacent facilities. Regulations, codes, standards, and other design documents generally specify depth of cover and horizontal and vertical clearances between adjacent facilities. However, they are not always prescriptive and can be subject to interpretation by the designer. In addition, certain codes allow exceptions to the prescribed minimum clearances, contingent upon approval between the affected facility owners/operators. The designer also must consider the protection and temporary support of adjacent facilities and any interference to existing cathodic protection and grounding systems. Consequently, the designer must provide specifications of safety measures to be taken and procedures for emergency notification and repairs in case an adjacent facility is damaged. Designers are aware of proposed and revised standards and codes that may affect the project.

**Benefits:**

The designer who reviews codes pertaining to adjacent facilities minimizes any potential conflict of code clearance requirements and facilitates future locating efforts.

## 2-7: Use of Qualified Contractors



**Practice Statement:** Qualified contractors are used to excavate on and near underground facilities.

**Practice Description:** Contractors that excavate on and near underground facilities possess the qualifications necessary to conduct such activities in a manner that is skillful, safe, and reliable. The requisite qualification of the contractor serves to protect the public and the integrity of underground facilities in the vicinity of the excavation. Using qualified contractors ensures that all contractors who bid and work on a project employ safe work habits and are capable of performing the requested work. When working with contractors, the project owner is familiar with the contractors' work experience and financial abilities and does not ask the contractors to bid beyond their capabilities. Allowing a competitive bidding process from qualified and competent contractors ensures the best quality and pricing available while reducing damages to underground facilities.

**Benefits:**

- Enhances safety
- Increases the quality of work
- Reduces damage to facilities

**References:**

- Florida Law (Chapter 337.14 FS) and Rules of the State of Florida, Department of Transportation, Chapters 14–22
- Duke Energy of Houston, Texas, procedures

## 2-8: Mandatory Prebid Conferences



**Practice Statement:** A mandatory prebid conference is held and bids are accepted only from attending contractors.

**Practice Description:** Depending on the level of impact of proposed construction upon facilities in the excavation area, the project owner or project designer requires potential contractors and facility owners/operators to attend a mandatory prebid conference. This prebid conference is used to discuss, among other things, the particular facilities in the area and the requirements to properly protect, support, and safely maintain the facilities during excavation. Official minutes are taken and disseminated as written to all attendees.

**Benefits:**

Prebid conferences provide a forum for the contractor, owner, and other interested parties to discuss a project and record binding changes or clarifications to the scope of the project. The prebid conference also provides an opportunity for all parties to review contract documents, regulatory requirements, schedules, and submittal formats. Most large projects involve multiple levels of subcontracting activity as well as multilayered regulatory oversight. The prebid conferences traditionally address these issues in an open forum so that all bidders are equally aware of the ground rules. The ground rules can be both commercial and technical in nature, covering the spectrum from performance bonds to safety practices.

**References:**

- Industry and governmental practices
- Florida Department of Transportation
- Duke Energy of Houston, Texas, procedures

## 2-9: Continuous Interface between the Designer and Potential Contractors During the Prebid/Bid Phase



**Practice Statement:** Once a project design is completed, the designer participates in the prebid/bid process.

**Practice Description:** The designer's continuing involvement during the prebid/bid phase with the potential contractor(s) allows for more effective communications between all parties. The designer can assess whether the interested bidders have the expertise needed and the correct understanding of the intended design.

**Benefits:**

- By providing quality assurance, this practice minimizes potential safety concerns and delays to project completion.
- The designer would have the opportunity to relay information not readily shown on the plans, such as accommodations of facility adjustments required to construct the project.

**References:**

- Industry practice
- Expert opinion

## 2-10: Continuous Interface between the Designer and the Contractor During the Construction Phase



**Practice Statement:** The designer continues to interface with the selected contractor throughout the construction phase.

**Practice Description:** This practice allows the designer to be available for preconstruction conferences, unforeseen conditions, and design changes; and for postconstruction conferences.

**Benefits:**

- Potential safety concerns are resolved more quickly, thereby minimizing subsequent modifications to the project design, costs, and completion.
- The designer's inspections of the project during different stages are facilitated.

**References:**

- Industry and government practice

## 2-11: As-built Drawings



**Practice Statement:** As-built drawings are prepared and the information is recorded to aid future excavations and locates.

**Practice Description:** Installation is made in accordance with the approved construction plans. Any deviation to the plans is documented and such changes are indicated on the as-built drawings. As-built information is recorded, retained, and made available for subsequent excavation.

**Benefits:**

As-built drawings serve as an information source for future projects to minimize damage to existing facilities.

**References:**

- Union Pacific Railroad procedures
- Expert opinion.
- Industry and governmental practices

## 2-12: Supply-line Separation



**Practice Statement:** When installing new direct-buried supply facilities in a common trench, a minimum of 12 in. radial separation is maintained between supply facilities, such as steam lines, plastic gas lines, other fuel lines, and direct-buried electrical supply lines. If 12 in. of separation cannot be feasibly attained at the time of installation, then mitigating measures are taken to protect lines against damage that might result from proximity to other structures. Examples may include the use of insulators, casing, shields, or spacers. If there is a conflict among any of the applicable regulations or standards regarding minimum separation, the most stringent are applied.<sup>6/</sup>

**References:**

- National Electric Safety Code IEEE C2-2007 (2007 Edition)
- Industry practices

## 2-13: Trenchless Excavation



**Practice Statement:** All stakeholders adhere to all best practices and the following general guidelines prior to, during, and after any trenchless excavation (as applicable).

**Practice Description:**

- The project owner and design engineer take prudent measures to make the determination to use trenchless excavation installation.
- The project owner and design engineer coordinate with facility owners to design projects that maintain minimum radial clearances between the new facility and existing facilities. Minimum clearances are equal to or greater than applicable standards.
- The project owner and design engineer establish line and grade of the proposed excavation to maintain the established minimum clearances. (See also Best Practices 4-19 and 5-29).<sup>13/</sup>

**References:**

See Appendix D



## 2-14: Subsurface Utility Engineering (SUE)



**Practice Statement:** When applied properly during the design phase, Subsurface Utility Engineering (SUE) provides significant cost and damage-avoidance benefits and the opportunity to correct inaccuracies in existing facility records.<sup>19/</sup>

**Practice Description:** In certain cases and environments, it may be difficult or impossible to determine the locations of all utilities and/or impediments with sufficient accuracy to avoid damage or delay during construction. In these cases, SUE is applied during the design phase to locate, identify, and characterize all existing utility infrastructure (and other relevant nonutility features) found within a given project/area. SUE is applied in a structured manner in accordance with practices and quality levels found in ASCE 38-02 “*Standard Guideline for the Collection and Depiction of Existing Subsurface Utility Data*.” The project owner dictates the required quality levels as well as the amount of effort expended by the SUE provider on each. Although the standard is more detailed and comprehensive, the following is a brief summary of the quality levels defined therein:

- QL-D involves utility records research and interviews with knowledgeable utility personnel.
- QL-C involves surface survey and identifying and recording aboveground features of subsurface utilities, such as manholes, valves, and hydrants.
- QL-B involves application of “surface geophysical methods,” such as EM-based locating instruments, GPR, radar tomography, metal detectors, and optical instruments, to gather and record approximate horizontal (and, in some cases, vertical) positional data.
- QL-A involves physical exposure via “soft-digging” (vacuum excavation or hand-digging) and provides precise horizontal and vertical positional data.

SUE results are integrated into the design process, in which design engineers use the information to create construction plans that accommodate existing infrastructure, thereby reducing the overall risk of conflicts and/or damage.<sup>11/</sup>

### References:

- U.S. Department of Transportation—FHWA (12/1999). *Cost Savings on Highway Projects Utilizing Subsurface Utility Engineering*. Pub. No. FHWA-IF-00-014
- U.S. Department of Transportation—FHWA (3/2001). *Subsurface Utility Engineering: Enhancing Construction Activities*. Pub. No. FHWA-IF-01-011
- ASCE 38-02 *Standard Guideline for the Collection and Depiction of Existing Subsurface Utility Data*
- Pennsylvania state law

## 2-15: Use of Qualified Designers



**Practice Statement:** Project owners employ qualified design and SUE providers.

**Practice Description:** When new utility infrastructure is installed, project owners employ qualified designers and SUE providers. Such providers have knowledge and understanding of applicable CGA Best Practices and of the ASCE 38-02 SUE standard. Providers are qualified in application of the associated design practices and SUE processes. The providers also are knowledgeable of the operation of any involved equipment and interpretation of results where applicable. Use of qualified SUE providers provides higher quality information to designers, who in turn can minimize utility conflicts by better depicting actual subsurface conditions on the construction plans.<sup>21/</sup>

See also

- Practice Statement 2-3: Identifying Existing Facilities in Planning and Design
- Practice Statement 2-7: Use of Qualified Contractors
- Practice Statement 2-14: Subsurface Utility Engineering (SUE)

**References:**

- New Jersey Public Service Electric and Gas

## 2-16: Project Coordination<sup>25/</sup>



**Practice Statement:** Large and/or complex projects may require the use of specific processes established to enhance safety and to coordinate buried-facility damage-prevention efforts among all potentially affected stakeholders throughout the life of the project. Such processes are intended to compliment, and be used in addition to, standard and customary one call notification and locating practices.

**Practice Description:** A “large/complex” project is a single project or a series of repetitive, small, related-scope, short-term projects that impact facilities over a long period of time or over a large area. Such projects pose a unique set of safety and damage prevention challenges when using standard one call practices, specifically as they apply to ongoing locating and re-marking requirements. These unique challenges can be addressed by the establishment of special processes, including (but not limited to) the following:

- A method for identifying such projects
- Preplanning and design coordination
- Increased one call center involvement
- A formalized communication process among all affected stakeholders
- Project-specific marking agreements that address variance scenarios
- Regularly scheduled meetings of, and on-going communication among, all involved stakeholders
- Positive response

The purposes for establishing such processes are to enhance safety and to optimize the utilization of locating resources on large/complex projects.

**References:**

- Georgia Utility Protection Center (GAUPC) and Georgia Utility Facility Protection Act (GUFPA)
- Pennsylvania One Call and Pennsylvania Underground Utility Line Protection Act

## 2-17: Electronically Locatable Lines<sup>68/</sup>



**Practice Statement:** When designing and installing new facilities, a means is provided to allow the facilities to be electronically locatable.

**Practice Description:** Many facilities are damaged due to the fact of they cannot be located electronically. Non-conductive materials, such as PVC, cannot be located using traditional locate methods. When designing and installing non-conductive facilities, the use of a tracer wire or other method (refer to practice 2-5, Markers for Underground Facilities) is part of that design and installation. This will allow these facilities to be identified, located and marked prior to future excavation activities.

**References:**

- NC State Statute, Article 8A 87-121 (g)

## 2-18: Identifying Newly Installed or Under-Construction Facilities<sup>70/</sup>



**Practice Statement:** Facility owner or designee identifies with the One Call Center an underground facility that has been installed or is under construction but is not in service.

**Practice Description:** A facility owner provides the One Call Center with shape files or other suitable mapping data for the new or under-construction facility that follows an existing or new corridor. A new facility includes facilities installed but not placed into service.

# One Call Center

One Call Center    
  Facility Owner    
  Excavator    
  Locator    
  Project Owner    
  Designer

### 3-1: Proactive Public Awareness, Education, and Damage Prevention Activities



**Practice Statement:** The one call center has a documented and proactive public awareness, education, and damage prevention program.

**Practice Description:** The one call center seeks opportunities to promote the need to “Call Before You Dig,” to enhance awareness of responsibilities to safeguard workers and the public and protect the integrity of the buried infrastructure, to foster a cooperative approach between the owners of buried facilities and the digging community toward the prevention of damage to buried facilities, and to promote the service it provides. Typical call center activities include the following:

- Promotional items
- Media advertising
- Participation at safety meetings
- Seminars and trade shows
- Contractor awareness programs
- Distribution of education material describing how the one call system works
- Maintaining a database of active members of the local digging community
- Mediating and rationalizing the expectations of both the facility owners/operators and the digging community
- Participation in local damage prevention or facility location and coordination committees

**References:**

- One Call Systems International Voluntary Recognition Program
- Existing operating practices from various states’ one call centers
- OCSI Resource Guide 2009 (<http://goo.gl/kpIDT>)
- 49 CFR Part 192
- 49 CFR Part 198
- National Transportation Safety Board (NTSB) Safety Study (NTSB/SS-97/01; PB97-917003)

### 3-2: Specifically Defined Geopolitical Service Area with No Overlap



**Practice Statement:** The one call centers serving a specifically defined geopolitical area are structured so that an excavator need only make one call, and a facility owner/operator need only belong to a single one call center.

**Practice Description:** One call programs are designed to promote ease of use for members (facility owners/operators) and excavators. Although this ease of use is enhanced when a one call center serves a specifically defined geopolitical area that does not overlap with the service area of another one call center, non-overlapping service areas are not essential. There are three requirements that a one call program must meet to be considered as having implemented this best practice:

- The program permits an excavator to use a single point of contact to submit and follow up on a notice of intent to excavate and to notify affected facility owners/operators.

- The program permits a facility owner/operator to join a single one call center and receive all appropriate notices.
- The program is designed so that all pertinent information is shared among one call centers in the event more than one exists.

**References:**

- One Call Systems International Voluntary Recognition Program
- Existing operating practices from various states' one call centers
- NTSB Safety Study (NTSB/SS-97/01; PB97-917003)

**3–3: Formal Agreements with Members**



**Practice Statement:** Each member of the one call center abides by state/provincial statute where applicable or written agreement that states the rights and the responsibilities of the one call members and the one call center.

**Practice Description:** Operating procedures and bylaws are established. Procedures for the operation of a one call center are simple. The concept is to promote service, not paperwork. Topics for procedures can be classified as general, communications, center operations, reports, expenses, and publicity. These topics can be expanded to include guidelines and whatever else is needed for a particular system. Bylaws vary, depending on the type of organization. In some instances they may prove unnecessary. If bylaws are adopted, simplicity is paramount. Items that can be incorporated include sections on membership (including rights), financial matters, meetings, elections, and duties of officers. Any other required agreements are kept as simple as possible to facilitate understanding by all participants. Consideration is given to include “hold harmless” clauses, amounts of liability insurance, errors and omissions insurance, retention of records, cost allocations, reimbursements, area served (with options to expand as planned), and any special arrangements necessary. If an agreement to contract the service to an outside concern is made, it contains controls, checks, and balances.

**References:**

- One Call Systems International Voluntary Recognition Program
- Existing operating practices from various states' one call centers
- OCSI Resource Guide 2009 (<http://goo.gl/kpIDT>)
- NTSB Safety Study (NTSB/SS-97/01; PB97-917003)

**3–4: One Call Center Governance**



**Practice Statement:** The one call center is governed by a board of directors representing the diverse makeup of the constituent groups (for example facility owners/operators, designers, contractors/excavators, and government).

**Practice Description:** To ensure that a one call center functions to the best benefit of the entire community, it is governed by a board of directors made up of representatives of the stakeholders. Board members are from a variety of industry types, such as facility owners/ operators, contractors, designers, project owners, and government representatives. Each board member is knowledgeable in their own industry and of how it interacts with the one call center and all of the represented stakeholders.

**References:**

- One Call Systems International Voluntary Recognition Program
- Existing operating practices from various states' one call centers
- NTSB Safety Study (NTSB/SS-97/01; PB97-917003)

### 3-5: Single Toll-free Statewide Telephone Number with Nationwide Access



**Practice Statement:** All one call centers have a single toll free statewide telephone number with nationwide access.

**Practice Description:** There is only one statewide toll-free telephone number for one call centers to receive locate requests. This number has nationwide access, meaning that a caller can reach the center from anywhere in the country.

**References:**

- One Call Systems International Voluntary Recognition Program
- Existing operating practices from various states' one call centers
- 49 CFR Part 198
- NTSB Safety Study (NTSB/SS-97/01; PB97-917003)

### 3-6: Hours of Operation<sup>55/</sup>



**Practice Statement:** The one call center can process locate requests 24 hours per day, 7 days per week.

**Practice Description:** The one call center has a process in place where an excavator who has a locate request can, at anytime of the day or night, every day of the year, contact the one call center and have that request processed.

**References:**

- Existing operating practices from various states' one call centers
- OCSI Resource Guide 2009 (<http://goo.gl/kplDT>)
- NTSB Safety Study (NTSB/SS-97/01; PB97-917003)

### 3-7: Voice Record of All Incoming Calls



**Practice Statement:** A voice recording is maintained of all voice transactions concerning requests to locate facilities.

**Practice Description:** A voice recording of telephone communications for locate requests is made to ensure that a precise record of the activity is retained. This recording can be legally supported in court as well as used for damage investigations.

**References:**

- One Call Systems International Voluntary Recognition Program
- Existing operating practices from various states' one call centers
- 49 CFR Part 198
- NTSB Safety Study (NTSB/SS-97/01; PB97-917003)

### 3-8: Retention of Voice Records According to Applicable Statutes



**Practice Statement:** Voice records of all calls concerning requests to locate facilities are retained according to applicable statutes.

**Practice Description:** Voice recordings are a factual record of the events that occurred between the caller and the one call center. These factual records must be maintained and made accessible until the applicable statute of limitations in the state/province has expired. Because these laws vary from state to state, no specific time period is set forth as best practice. In the absence of notice by some party to the contrary, the records may be destroyed after the expiration of the statute of limitations. The one call center has a procedure for processing requests for voice information.

**References:**

- One Call Systems International Voluntary Recognition Program
- Existing operating practices from various states' one call centers
- 49 CFR Part 198
- NTSB Safety Study (NTSB/SS-97/01; PB97-917003)

**3–9: Caller Feedback**



**Practice Statement:** The one call center provides the caller with a ticket number and the names of facility owners/operators who will be notified for each locate request.

**Practice Description:** Providing the locate request ticket number and the names of the facility owners/operators who will be notified enhances the efficiency of the one call process. When provided the names of the facility owners/operators, the excavator knows which owners/operators will be notified in the area of the planned excavation. This helps the excavator determine if the facility owners/operators have responded to the locate request.

**References:**

- One Call Systems International Voluntary Recognition Program
- “Model One Call for the 20th and 21st Century,” AT&T (was available when the practice was created but is no longer available)
- Existing operating practices from various states' one call centers
- 49 CFR Part 198
- NTSB Safety Study (NTSB/SS-97/01; PB97-917003)

**3–10: Printed Ticket Recall**



**Practice Statement:** The one call center can provide a printed copy of any ticket for a period of time determined by applicable statutes.

**Practice Description:** In the event a damage investigation, litigation, or other event occurs, it often is necessary to have a hard-copy printout of a locate request ticket. Local governments have statutory requirements for record retention in such cases. The one call center has the ability to produce, as necessary, a copy of a location request ticket for the appropriate statutory period.

**References:**

- One Call Systems International Voluntary Recognition Program
- Existing operating practices from various states' one call centers
- 49 CFR Part 198
- NTSB Safety Study (NTSB/SS-97/01; PB97-917003)

**3–11: Documented Operating Procedures, Human Resource Policies, and Training Manuals**



**Practice Statement:** The one call center has documented operating procedures, human resource policies, and training manuals.

**Practice Description:** The one call center has documented operating procedures, human resource policies, and training manuals. Training manuals, practices, procedures, and policies are on the premises in a designated area or place, are dated, and are available for reference.

**References:**

- One Call Systems International Voluntary Recognition Program
- Existing operating practices from various states' one call centers
- NTSB Safety Study (NTSB/SS-97/01; PB97-917003)

### 3–12: Documented Owner Verification of Data Submitted by Facility Owners/Operators



**Practice Statement:** The one call center returns the geographic description database documentation to the facility owner/operator annually and after each change for verification and approval.

**Practice Description:** The one call center can work only with the information related to the existence of buried facilities that its members provide. It is important that the one call center be able to produce evidence that a member's data is accurate, according to that member. Regular verification of data is a part of the documented agreement or operating procedures between the owner/operator of buried facilities and the one call center. Any deletions or additions made by the member are entered into the database, and documentation of the change is returned to the member for verification prior to activation.

**References:**

- One Call Systems International Voluntary Recognition Program
- “Model One Call for the 20th and 21st Century,” AT&T (was available when the practice was created but is no longer available)
- Existing operating practices from various states’ one call centers
- NTSB Safety Study (NTSB/SS-97/01; PB97-917003)

### 3–13: Flexibility for Growth and Change



**Practice Statement:** The one call center's operating plan is sufficiently flexible to accommodate growth and change.

**Practice Description:** A successful one call center maintains flexibility to respond to changes by forming and maintaining a responsive organization whose board of directors' composition allows adequate representation of the needs of all stakeholders. A board's ability to respond to change is enhanced by drafting bylaws and operating procedures that reflect the current environment in which the one call center serves. The most successful boards review these documents on an ongoing basis to ensure they continue to reflect or respond to current conditions. These boards conduct regular strategic planning sessions during which they review the current state of the center's major systems, programs, and outreach activities. Such assessments help the boards identify stakeholder needs for future growth and development. Many members of boards and center management teams stay informed about and involved in the one call industry by joining associations and attending conferences or other educational events that help them to better identify new opportunities for growth and change.

**References:**

- One Call Systems International Voluntary Recognition Program
- “Model One Call for the 20th and 21st Century,” AT&T (was available when the practice was created but is no longer available)
- Existing operating practices from various states’ one call centers
- NTSB Safety Study (NTSB/SS-97/01; PB97-917003)



### 3-14: Meeting between the Excavator and Facility Operator(s) Initiated by One Call Notification



**Practice Statement:** The one call center has a process for receiving and transmitting requests for meetings between the excavator and the facility operator(s) for the purpose of discussing locating facilities on large or complex jobs.

**Practice Description:** The one call center relays requests for job site facility meetings with facility owners/operators to the affected facilities owner/operator. If a meeting is required to show the limits and schedule of the work, the one call center indicates that a meeting is requested. The one call center requires that the excavator provide sufficient information to fully identify the boundaries of the proposed work site. A meeting request does not necessarily eliminate the need for a locate request.

**References:**

- Existing operating practices from various states' one call centers
- OCSI Resource Guide 2009 (<http://goo.gl/kpIDT>)
- NTSB Safety Study (NTSB/SS-97/01; PB97-917003)

### 3-15: One Call Center Accepts Notifications from Designers



**Practice Statement:** The one call center accepts design requests and has the ability to process them as designated by the facility owners/operators.

**Practice Description:** To facilitate damage prevention, project designers have a need for access to facility location information from facility owners/operators. If a design request is received, the one call center provides a listing of facility owners/operators directly to the designer. Once the list is identified, the one call center processes the request as designated by each facility owner/operator.

**References:**

- Existing operating practices from various states' one call centers
- NTSB Safety Study (NTSB/SS-97/01; PB97-917003)

### 3-16: Locate Request



**Practice Statement:** The one call center captures the following information, at a minimum, on a locate request:

- Caller's name and phone number
- Excavator's/company's name, address, and phone numbers
- Specific location of the excavation
- Start date and time of the excavation
- Description of the excavation activity.

**Practice Description:** A locate request is a communication between an excavator and one call center personnel in which a request for locating underground facilities is processed. In addition to the minimum required information identified in the preceding paragraph, the locate request includes any available information that will help establish the specific location of the excavation site. This additional information could include the following, for example:

A: More detailed information to help determine the specific location of the excavation, such as the following:

- 1: City
- 2: County/parish/township
- 3: State/province
- 4: Street address

- 5: Street name
  - 6: Length and direction of the excavation and the nearest adjacent cross streets (needed to bound area of excavation or extended excavation)
  - 7: Subdivision and lot number (for new development)
  - 8: X/Y coordinates—a means of defining horizontal position—the dig site can be a point, an area or box, or a polygon. For a spatial rectangle (maximum/minimum latitude/longitude), the dig site must be wholly within the specified area.
    - a: Latitude/longitude coordinate(s) or specific address of the dig site. These may be done automatically by the GIS subsystem or determined by a computer-assisted customer service representative.
    - b: GPS coordinates. When the excavator provides GPS coordinates to the one call center and when the call center has the technical capabilities to capture this information, the GPS format is also specified (decimal degrees; degrees/decimal minutes; or degrees/minutes/seconds) and included on the ticket.<sup>61/</sup>
  - 9: Highway mile markers
  - 10: Railroad mileposts
  - 11: General directions/instructions
  - 12: Map grids
  - 13: Distance to nearest cross street
  - 14: Any other pertinent references to help establish the location of the dig site
- B: The intended start date and time of the excavation (i.e., the date excavation is actually expected to begin, which may be later than when excavation can legally begin based on the ticket date)
- C: Type of excavation activity (e.g., boring, blasting, trenching, trenchless, etc.)
- D: For whom the excavation work is being done
- E: The purpose of the work (i.e., what will be installed or built)
- F: Additional remarks

**References:**<sup>61/</sup>

- “Model One Call for the 20th and 21st Century,” AT&T (was available when the practice was created but is no longer available)
- Existing operating practices from various states’ one call centers
- 49 CFR Part 198
- Kansas One-Call: Excavator’s Manual. “Rural Area,” pg 9.  
<http://www.kansasonecall.com/excavators/reference-materials/excavator-s-manual/>
- Tennessee 811:
  - Geocall V3 CGAE.28 Rev 012813 “Latitude and Longitude Searches,” pg 1.
  - Geocall V3 CGAE.29 Rev 062713 “Latitude and Longitude Searches,” pg 1.
  - Geocall V3 CGAG.40 Rev 020413 “Latitude and Longitude,” pg 1.
  - Geocall V3 CGAG.41 Rev 020413 “Latitude and Longitude,” pg 2.
- New Mexico 811: Training Manual. 8.14 “How to Use GPS for Mapping a Ticket,” pg 1–16.
- Mississippi 811: Training Manual. “Global Positioning System/Latitude-Longitude,” pg 1.

- Hawaii One Call: ITIC User Manual. “Submit a Locate Request,” pg 16. <http://callbeforeyoudig.org/hawaii/index.asp>
- Montana One Call: ITIC User Manual. “Submit a Locate Request,” pg 16, 23. <http://callbeforeyoudig.org/montana/index.asp>
- Illinois 811: Excavators. “Information Needed,” <http://www.illinois1call.com/excavators/infoneeded.html>

### 3–17: Practices to Reduce Overnotifications



**Practice Statement:** The one call center employs practices designed specifically to reduce the number of notices transmitted to facility owners/operators in which the reported excavation site is outside the owner’s/operator’s desired area of notification.

**Practice Description:** The one call center employs technology that enables the facility owner/operator to determine its desired area of notification by either polygons or grids. To reduce overnotifications, technology includes, but is not limited to, the following:

- Enables the one call center to define the proposed excavation site buffer to within approximately 800 ft
- Enables the facility owner/operator to identify its desired area of notification to within approximately 100 ft

**References:**

- “Model One Call for the 20th and 21st Century,” AT&T (was available when the practice was created but is no longer available)
- Existing operating practices from various states’ one call centers
- NTSB Safety Study (NTSB/SS-97/01; PB97-917003)

### 3–18: Disaster Recovery



**Practice Statement:** A one call center develops, implements, and maintains an effective disaster recovery plan that enables the one call function to continue in the event of a disaster.

**Practice Description:** The one call center develops and implements an effective disaster recovery plan that enables it to continue operations in the aftermath of a disaster affecting the facility. Excavators and underground facility owners/operators outside of the area affected by the disaster can continue to conduct business with minimum to no delays in the services provided by the one call center. The disaster recovery plan makes provisions for the one call center to process emergency locate requests for the areas affected by the disaster. The one call center (the primary center) has a backup arrangement with another facility at a remote location (the secondary center). This arrangement includes the following:

- Telecommunications—alternate routing schedules are in place and ready to be activated within minutes of the primary centers’ failure.
- Software and hardware—the secondary center has compatible hardware with the primary center. The secondary center always has a copy of the primary’s current software.
- Database—the secondary center receives the primary center’s database, including locate requests, on a regular basis and preferably in real time.
- Staffing—a portion of the secondary center’s staff is cross-trained for the primary center’s operation at all times.
- Simulated emergency testing—at least once a year, on a random basis, the disaster recovery plan is implemented to verify that it is operational.

**References:**

- “Model One Call for the 20th and 21st Century,” AT&T (was available when the practice was created but is no longer available)
- Existing operating practices from various states’ one call centers

### 3–19: Direct Electronic Locate



**Practice Statement:** The one call center provides users a means of direct, electronic entry of locate requests that maintain comparable ticket quality to an operator-assisted entry.

**Practice Description:** The one call center has interactive data communications sufficient to permit remote data entry for members and excavators. The remote interface validates the input information and allows the user to make corrections if necessary. This correction is accomplished by referencing the same geographic database used at the one call center when taking a called-in request. This process ensures that the ticket quality is maintained for all tickets.

**References:**

- “Model One Call for the 20th and 21st Century,” AT&T (was available when the practice was created but is no longer available)
- Existing operating practices from various states’ one call centers
- NTSB Safety Study (NTSB/SS-97/01; PB97-917003)

### 3–20: Accept Multiple Reference Points for Locate Requests



**Practice Statement:** The one call center can accept multiple types of points of reference to define the exact location of an excavation site (e.g., latitude/longitude, highway/railroad/pipeline mile markers, address, street/cross street, etc.).

**Practice Description:** The one call center’s locate request-taking processes and computer system are designed to accept and process multiple types of reference points used by callers to (1) describe the location of their work and (2) define the excavation site. Examples of different types of reference points include highway mile markers, railroad mileposts, valid address or street/cross street, latitude longitude, township/range/section, city, county, political and mail address (ZIP code) boundaries, etc. All stakeholders involved in the one call process receive a corresponding benefit when the one call center can define the excavation site as specifically as possible. The facility operator’s job of determining the existence of a potential conflict is expedited, field personnel can find and mark the affected area much easier, and the excavator receives timely markings covering the area of excavation. Standardizing a limited set of criteria reduces the flexibility of the system to serve the excavator and facility owner/operator. The one call center invests in systems and processes that permit inclusion of a variety of types of reference points in defining the excavation site. The one call center takes steps to link these reference points to the database used to register the facility operator’s desired area of notification, thereby helping to reduce overnotification.

**References:**

- “Model One Call for the 20th and 21st Century,” AT&T (was available when the practice was created but is no longer available)
- Existing operating practices from various states’ one call centers

### 3–21: One Call Center Security



**Practice Statement:** The one call center provides appropriate physical and systems security, fire protection, and electrical protection to protect the one call center and its critical components.

**Practice Description:** The one call center needs protection from natural disasters and other threats. Because the one call center is a critical link in the communication chain between the excavating community and facilities, it is important that the one call center does whatever it can to provide adequate security, taking into account that it may well need to be operational in times of natural disasters or in the face of other threats. Security components could include the following:

- Physical security for the building and its employees through locked operations areas, lighting, employee key cards, and guard patrols
- Physical security for critical systems components that may include locating the facilities in locked enclosures and restricting access to necessary personnel
- General fire protection for the one call center personnel and property
- Specialized fire protection for critical systems components
- Specialized theft protection for critical systems components
- Telephone demarcation points in a protected area within the one call center
- Passwords and protections to limit access to computers and other systems.
- Off-site storage of a duplicate database and necessary system software.

**Reference:**

- Existing operating practices from various states' one call centers

### 3–22: Hardware Designed to Tolerate a Single Point of Failure



**Practice Statement:** The one call center uses fault-tolerant hardware for its critical path operations, such as ticket taking, database access, and ticket delivery.

**Practice Description:** A fault-tolerant system can withstand any single hardware malfunction without any interruption or degradation of service. These systems have the ability to identify the malfunctioning hardware component and permit its replacement while remaining online and processing normal applications. These fault-tolerant systems maximize the probability that the one call center will be able to properly process an excavation request in the event of a failure or malfunction.

**References:**

- “Model One Call for the 20th and 21st Century,” AT&T (was available when the practice was created but is no longer available)
- Existing operating practices from various states' one call centers

---

### 3-23: One Call Quality Standards<sup>24/</sup>



**Practice Statement:** The one call center establishes and monitors performance standards for the operation of the center.

**Practice Description:**

A: Customer Quality of Service Performance Measurements

One call centers monitor the quality of service provided to a customer who phones in a locate request. Key performance indicators include, but need not be limited to, average speed of answer, call abandonment rate, busy signal rate, and customer satisfaction. The recommended benchmarks to fulfill a high quality of customer service while promoting accuracy, cost effectiveness, and efficiency are identified below. Meeting or exceeding a benchmark qualifies as a “best” practice.

1: Average Speed of Answer

Average speed of answer (ASA) usually comprises the number of seconds between the time a caller is transferred from the Interactive Voice Response (IVR) system and the time a voice welcomes the caller and begins the processing of a locate request averaged over a specified time interval and accumulated daily.

Service level objectives in the one call center industry are generally monitored daily, monthly, and year to date. An ASA objective of 30 seconds or less is recommended.

2: Abandoned Call Rate

The incidence of abandoned incoming calls is a function of the number of one call center customer service representatives actively processing locate requests and the volume of incoming calls. Callers have an expectation that all calls will be answered within a reasonable time. A caller that has waited more than 60 seconds before hanging up is considered an abandoned call.

A monthly average abandonment rate that is less than 5% is recommended.

3: Busy Signal Rate

The incidence of callers experiencing busy signals is a function of the number of incoming telephone lines to the one call center and the incoming call volume. Callers have an expectation that there will be very few busy signals.

Typically, one call centers can extract information on busy signals from their telephone systems or obtain the information from their communications service providers. The information usually comprises the number of callers experiencing a busy signal as a percentage of the total number of attempts to contact the one call center during normal business hours.

Service level objectives are reported daily, monthly, and year to date. A monthly average busy signal rate that does not exceed 1% is recommended.

4: Customer Satisfaction

A fundamental principal in measuring quality is that “the customer defines quality.” Periodic customer satisfaction surveys are conducted.

The one call center makes all information/data collected on the quality of its performance available for review by the appropriate oversight authority and the public upon request.

B: Locate Request Quality

The one call center has in place quality control and quality assurance programs to measure and monitor the accuracy and completeness of the information received by the one call center compared to the information transmitted by the one call center.

C: Notification Delivery

The one call center establishes and monitors criteria for the transmission of notifications and notification audit reports.

Typically, the one call center can transmit notifications in an electronic format that allows receiving stations to parse/extract data.

Notification audit reports are sent to receiving stations at a mutually acceptable frequency. It is a best practice to send an audit report at least once every business day.

Typically, notification transmission is immediate.

**References:**

- One Call Systems International Voluntary Recognition Program
- “Model One Call for the 20th and 21st Century,” AT&T (was available when the practice was created but is no longer available)
- Existing operating practices from various states one call centers

**3–24: Web Services Solution<sup>17/</sup>**



**Practice Statement:** The one call center provides a method by which a member operator can receive excavation notifications through a secure Web service that uses an accepted standard for its ticket format, such as Extensible Markup Language (XML) 1.0.

**Practice Description:** In addition to all other methods and formats used by one call centers to communicate excavation notifications to underground facility owner/operators that do not have automated ticket management systems, one call centers also should provide a method that is consistently secure and reliable. Establishing this method within the one call centers along with an accepted standard format such as Extensible Markup Language (XML) 1.0 satisfies this practice. Providing e-mail and/or File Transfer Protocol (FTP) communications methods alone does not satisfy this practice.

**References:**

- Sunshine State One Call of Florida
- Utility Protection Center of Georgia
- Dig Safely New York
- Ohio Utilities Protection Service
- Arizona Blue Stake, Inc.

### 3–25: Identification of Unknown Lines<sup>15/</sup>



**Practice Statement:** The one call center has a defined and documented policy for handling calls from excavators regarding the discovery of an unidentified line.

**Practice Description:** To facilitate damage prevention, one call centers have an established procedure that is implemented when an excavator calls and reports an unidentified facility. The action taken could be as simple as renotifying all affected facility operators in the absence of any other specific requirement of state or local law.

**References:**

- Many one call centers process a “Dig Up” request when an unidentified line has been exposed (Texas). Others simply reissue the locate request with an appropriate remark (Maryland, Delaware). Some state laws mandate that additional specific action be taken by the facility operators upon receipt of these types of notices (Arizona, which currently requires an “unknown line policy” to be in effect via the Arizona Blue Stake One Call Center). The law requires that the one call center “establish a method of providing personnel from a facility owner qualified to safely inspect and verify that the facility is abandoned or active and a method for reimbursing the verifying facility owner for the cost incurred.”

### 3–26: One Call Membership<sup>22/</sup>



**Practice Statement:** Any entity that furnishes or transports products or services to a third party for its use or consumption by means of an underground facility or furnishes or transports products or services for its own internal use by means of an underground facility that occupies or crosses a right-of-way or utility easement is a member of a one call center.

**Practice Description:** Underground damage prevention begins with a notice of intent to excavate submitted by an excavator to the appropriate one call center. The process of notification depends on all affected member facility operators being notified of intent to excavate through the regional one call center.

Membership in the one call center by underground facility operators ensures that potential conflicts with existing facilities that may be encountered during excavation activities are identified by using a single regional point of contact. Operators of the aforementioned underground facilities who fail to become members of their local one call center risk public safety and damage to their facilities, and endanger excavators who may come into contact with these aforementioned underground facilities.

The following are examples of an underground facility that would probably not require one call center membership:

- The internal use of owned underground facilities to provide safe operations in controlled rights of ways, such as railroad operating corridors that facilitate the transportation of freight or passengers.
- The internal use of an entity’s underground facilities by that entity solely on its own property. (Note: aboveground use of one’s rights of way or property, such as the transportation of freight or passengers by rail, is not within the purview of the CGA Best Practices.)

**References:**

State One Call Laws, 1999 Common Ground Study



**3–27: Electronic Positive Response<sup>46/</sup>**



**Practice Statement:** The one call center provides a method for facility owner/operators to electronically post their positive response status to a notice of intent to excavate.

**Practice Description:** By hosting an electronic positive response system, the one call center provides facility owner/operators the best means to communicate the status of their response to a notice of intent to the person initiating the notice.

**References:**

- BP 4-9 Positive Response Is Provided to Facility Locate Requests
- Existing practice in Arizona, Colorado, Delaware, Florida, Georgia, Iowa, Maryland, Michigan, New Jersey, New Mexico, North Carolina, Ohio, Pennsylvania, Tennessee, Virginia, West Virginia, and Washington, D.C.

**3–28: One Call Center Data<sup>53/</sup>**



**Practice Statement:** All one call centers annually submit their ticket and transmission volumes to the OCSI Data Collection Tool.

**Practice Description:** Ticket and transmission volumes from the One Call Systems International (OCSI) data collection tool are shared with the Damage Information Reporting Tool (DIRT) to make a correlation between one call center ticket and/or transmission volume to damages or events that have occurred. Many one call centers currently provide this data to the OCSI data collection tool. Receiving ticket and transmission volumes from all one call centers allows all stakeholders to review, on a national level, more accurate projections and to determine the cause and possible solutions for damages to subsurface installations.

**References:**

One call centers who participate currently:

AL —Alabama 811	LA —Louisiana One Call System	OH —Ohio Utilities Protection Service
AR —Arkansas One Call System	MA —Dig Safe System	OR —Oregon Utility Notification Ctr
AZ —Arizona Blue Stake	ME —Dig Safe System	PA —Pennsylvania One Call System
CA —USA North	MI —Miss Dig System	RI —Dig Safe System
CA —USA South	MN —GopherState One Call	SD —South Dakota One Call
CO —Colorado 811	MO —Missouri One Call System	TN —Tennessee 811
CT —Call Before You Dig	MS —Mississippi 811	TX —Texas 811
FL —SunshineState One Call	NC —North Carolina 811	UT —Blue Stakes of Utah
GA —UtilitiesProtectionCenter	NH —Dig Safe System	VA —Miss Utility of Virginia
IA —Iowa One Call	NM —New Mexico One Call	VT —Dig Safe System
ID —Dig Line	NV —USA North	WA —Oregon Utility Notification Ctr
IN —Indiana 811	NY —New York 811	WI —Diggers Hotline
KS —Kansas One Call System	NY —Dig Safely New York	WV —Miss Utility of West Virginia
KY —Kentucky 811		

### 3-29: One Call Facility Locate Request Size and Scope<sup>54/</sup>



**Practice Statement:** A maximum locate request area that is appropriate for a proposed excavation site is defined for a facility locate request.

**Practice Description:** Designating a manageable locate request size (work area size/scope) along with clear locate instructions will reduce uncertainty and provide clarity to the utility operators and/or locators as to "what" and "where" needs to be located and marked. This is designed to prevent unnecessary locator effort and allow adequate time to locate and mark the affected underground facilities within the time frame and marking requirement of the appropriate state statute.

**References:**

- Existing state laws, including Georgia, Indiana, Pennsylvania, and South Carolina (as examples)

### 3-30: Locate Information Shared with Excavator<sup>60/</sup>



**Practice Statement:** The one call center provides locate request information to the excavator.

**Practice Description:** Providing locate request information to the excavator enhances the one call communication process. By providing the excavator with a record of information communicated to facility owners, operators, and locators by the one call center in response to the excavator's locate request, the excavator is able to verify the accuracy of the information. This information includes but is not limited to contact information, work type, excavation activity duration, ticket life, as well as the proposed location of excavation activities.

**References:**

- North Carolina 811
- Pennsylvania 811

### 3-31: Enhanced Positive Response<sup>66/</sup>



**Practice Statement:** Enhanced Positive Response is utilized, where available, to provide additional information to the excavator about a performed locate.

**Practice Description:** This information provided to the excavator, prior to excavation, will help the excavator know more about the utilities and job site prior to dispatching resources to excavate. With this additional information, the excavator will be able to plan the excavation to reduce damage to underground utilities.

This communication may include documentation and any other information that will promote safe excavation including details about the locate and the facility owner.

It is a common practice for utility operators and contract locators to capture the enhanced information about locates that are performed in response to one call centers requests.

Sharing this enhanced information with the excavator, prior to excavation, will help to reduce damage to underground facilities and provide clarification of the location of each utility.

**References:**

- A pilot program was successfully implemented in 2014 in Montgomery County, MD. The success of the pilot program encouraged utilization of the EPR throughout Washington Gas distribution system. Beginning May 2015, there have been over 1,000,000 EPR packages provided system-wide.

- The proposed practice enhances Locating and Marking BP 4.9 and 4.13. The proposed EPR will provide support for Excavation BP 5.8, 5.10, 5.11, 5.13, and 5.14.
- EPR is in use as a daily process by Washington Gas, UtiliQuest, and Miss Utility (OCC) call center for all locate requests in Washington DC and MD.

### 3–32: Communicate Potential for Privately-Owned Facilities



**Practice Statement:** The One Call Center educates individuals submitting a locate request that privately-owned-and-operated service lines/facilities may exist. Owners/operators of those private service lines/facilities who are not members of the One Call Center will not be notified.

**Practice Description:** The purpose of this practice is to make the individual submitting a locate request aware that the One Call Center will notify only its members who are obligated to respond. Buried private service lines/facilities that are owned and operated by nonmembers may be present and will not be located.

Best Practice 4–21 in the Locating and Marking chapter recognizes the practice and the obligation of Operators to locate and mark their service lines/facilities connected to main lines/facilities.

Practices outlined in Best Practices 2–3 and 2–14 in the Planning and Design chapter should identify public and private lines/facilities at the design phase. The locations of those lines/facilities should be verified and documented before the construction phase.

Entities and individuals who are not members of the One Call Center and are not in the business of providing a product or service with service lines/facilities will not be notified. The One Call Center explains to individuals requesting a locate or to visitors to their websites that private service lines/facilities may exist and will not be located.

**References:**

- Arizona 811, Colorado 811, Kentucky 811, Pennsylvania 811, Mississippi 811, Gopher State One Call, Georgia 811, Illinois One Call

## CHAPTER 4

# Locating and Marking



One Call Center



Facility Owner



Excavator



Locator



Project Owner



Designer

### 4-1: Available Records



**Practice Statement:** Locators use available facility records at all times.

**Practice Description:** Facility locators use available records at all times. Facility records indicate approximate location, number of facilities, and access points for buried facilities within a requested area. The use of facility owner/operator-supplied records is an effective method of identifying facilities as part of the locating process.

### 4-2: Corrections and Updates



**Practice Statement:** If a facility locator becomes aware of an error or omission, then the facility locator provides information for updating records that are in error or for adding new facilities.

**Practice Description:** During the course of a locating activity, a locator may become aware of errors or omissions. Methods are in place to notify a facility owner/operator of that error or omission. The corrections are submitted to the appropriate person or department in a timely manner. The method of notification is determined by the facility owner/operator and includes the following information:

- Name (and company if contracted)
- Contact phone number of the individual(s) submitting change
- Location (either address or reference points)
- Size and type of facility
- Nature of the error or omission
- Sketch of the change in relation to the other facilities

Omissions and errors may occur as a result of misdrawn records, changes during construction at the job site, repair or abandonment of facilities, and delays in posting new records. Failure to note errors or omissions when found could result in damages to the facility at a later date. The 1994 NTSB Excavation Damage Prevention Workshop stated that “facility operators should be required to update maps when excavation finds errors in the mapping system.”<sup>1/</sup>

### 4-3: Color Code



**Practice Statement:** A uniform color code and set of marking symbols is adopted nationwide.

**Practice Description:** A national standard is adopted defining color specifications relevant to facility type and marking symbols for identifying facilities. (See Appendix B, “Uniform Color Code and Marking Guidelines.”)<sup>9/</sup> The December 1997 NTSB safety report cites the use of the APWA/ Utility Location and Coordination Council (ULCC) color code as the model example.

#### 4-4: Single Locator



**Practice Statement:** A single locator is used for multiple facilities.

**Practice Description:** This practice is employed when determined to be advantageous by the facility owner/operator. The use of a single locator to mark multiple facilities may provide several advantages to both the facility and the excavating communities. These advantages can include the following:

- More responsive service to the excavation community
- Better communication with the excavating community (fewer points of contact)
- Improved safety as a result of less traffic on the road
- Improved worker safety
- Reduced environmental impact
- Maps of multiple facilities

Note: this best practice does not suggest that all facilities be located by a single locator, but rather that conditions exist in which locating multiple facilities with a single locator will reduce the likelihood of errors and resulting damage (e.g., multiple facilities with the same owner or multiple facilities that are marked with the same or similar color codes). This practice has been employed by a facility owner in Michigan to enhance safety. The use of a single locator to locate multiple facilities is analogous to the use of a one call center to handle locate requests from excavators. The use of a one call center allows locate requests for multiple facilities at an excavation site to be issued through a single point of contact, simplifying communications. The use of a single locator to carry out locate requests for multiple facilities further simplifies communications, with fewer links needed between excavator and locator.

#### 4-5: Locator Training



**Practice Statement:** Locators are properly trained. Locator training is documented.

**Practice Description:** Minimum training guidelines and practices are adopted for locator training. These guidelines and practices include the following:

- Understanding system design/prints/technology
- Understanding construction standards and practices for all types of facilities
- Equipment training and techniques
- Plant recognition training
- Theory of locating
- Daily operations
- Facility owner/excavator relationships and image
- Safety procedures per Occupational Safety and Health Administration (OSHA) regulations/federal, state/provincial and local laws
- Written and field testing
- Field training
- Annual retesting

The National Utility Locating Contractors Association (NULCA) Locator Training Standards and Practices<sup>2/</sup> represent an accepted model within the locate industry. Documentation of all training is maintained to ensure that facility locators have been properly trained.

## 4–6: Safety



**Practice Statement:** Locates are performed safely.

**Practice Description:** It is the responsibility of the owner/operator and locator to establish when and how the underground facility will be identified. All hazards associated with performing a locate are identified. Appropriate measures conforming to federal, state/ provincial, local, and industry standards are established. Employees are made aware of these hazards and are properly trained in worker safety standards.

### A: Pre-Work Safety Considerations

- 1: **Site Background Data.** Site information is gathered to determine hazards, exposures, and/or other potential safety problems that might be encountered in connection with on-site locate work. This information may be gathered from the facility records and from visual inspection.
- 2: **Site Familiarization.** Site characteristics that could affect locate work are analyzed. Areas to be considered include the following:
  - a: **Obstructions.** The site is analyzed to determine if physical obstructions are present on the property that would make locate work unsafe. Means for working around such obstructions are defined.
  - b: **Traffic.** Vehicular arteries (e.g., highways, roadways, railways, etc.) at the work site are identified to determine whether such traffic would pose any safety hazard to locating the site.
  - c: **Physical Site Conditions.** Soil conditions and other factors (e.g., trenches, pits, bores, standing water, etc.) that could affect the safety of the job site are identified. Methods are developed to identify and safely work around these hazards.
- 3: **External Resources.** Information is gathered about safety-related resources that might be required in the event of an accident or other problem (such as an employee illness). Information needed includes location and contact information for the nearest hospital, fire department, police department, and any other public emergency response organization. In addition, access routes and travel plans to emergency response facilities are defined.
- 4: **Work Plan.** A work plan in which procedures, employee roles, equipment requirements, time requirements, and other factors are considered is developed to define the most efficient means for safely accomplishing required locate work. This work plan considers all of the safety related information developed in connection with paragraphs 4–6.A.2 and 4–6.A.3.
- 5: **Job Briefing.** Information developed as discussed in paragraphs 4–6.A.1 through 4–6.A.4 is used to conduct a job briefing prior to commencement of on-site locate work. The job briefing focuses on safety aspects of the required work.

### B: Locate Work Safety Considerations

- 1: **Personnel Protection.** Watchman/lookout capabilities are provided to ensure the safety of personnel in cases where locate work requires that working individuals disrupt traffic flow or otherwise occupy hazardous positions. All working individuals wear proper safety attire. Such attire provides for adequate visibility of the worker and personal protection against hazards.
- 2: **Equipment.** All equipment used in connection with locate work is suitable for the intended uses. Items such as ladders, electrical test devices, and other instruments and items are inspected from a safety perspective prior to use. Safety features such as locking devices, grounding, insulation, etc., are thoroughly inspected.

- 3: Exposures. In cases where locate work requires personnel to enter into spaces with potentially unsafe conditions, appropriate testing is accomplished prior to entry. During times when such spaces are occupied, adequate monitoring and/or ventilation devices are present and properly operating during occupancy.
- 4: Work Activities. All locate work activities are conducted with safety given first priority. All employees are thoroughly trained and briefed regarding safety measures such as minimizing exposures to potentially hazardous conditions, avoiding unnecessary risks, and giving priority to personal safety.

C: Post-Work Safety Considerations

- 1: Termination of Work Activities. After locate work is completed, the site is restored and left in such a condition that no safety hazards associated with the locate work activities remain. All personnel and equipment used in connection with the work are accounted for, and no unsafe conditions remain at the site. Any safety related equipment used in connection with the work is returned/restored to pre-work status.
- 2: Debriefing. After completion of locate work, a debriefing safety review of work activities is conducted. The review looks at the safety aspects of all applicable work practices to determine if unnecessary exposures may have occurred and where improvements could be made.

**4-7: Visual Inspection**



**Practice Statement:** A visual inspection is completed during the facility locating process.

**Practice Description:** This inspection includes the following:

- All facilities within a facility owner/operator's service area (to evaluate the scope of the locate request)
- Identification of access points
- Identification of potential hazards
- Assurance that plant facilities shown on records match those of the site

A visual inspection helps determine if there are facilities placed that are not on record. It is very important that visual inspections be completed in areas of new construction, where records may not indicate the presence of a facility. The visual inspection is necessary because the time between placing a facility in the field and placing it on permanent records varies by facility owner/operator and location. Evidence of a facility not on record includes, but is not limited to, poles, dips, enclosures, pedestals (including new cables found within the pedestals), valves, meters, risers, and manholes.

**4-8: Facility Marking**



**Practice Statement:** Facilities are adequately marked for conditions.

**Practice Description:** Facility locators match markings to the existing and expected surface conditions. Markings may include one or any combination of the following: paint, chalk, flags, stakes, brushes, or offsets. All marks extend a reasonable distance beyond the bounds of the requested area. Proper training for all facility locators includes properly identifying the varying surface and environmental conditions that exist in the field and what marking methods should be used. Conditions that may affect markings are rain, snow, vegetation, high traffic, construction, etc.

#### 4-9: Positive Response to Locate Request



**Practice Statement:** Positive response is provided to facility locate requests.

**Practice Description:** All facility locate requests result in a positive response from the facility owner/operator to the excavator. A positive response may include one or more of the following: markings or documentation left at the job site, callback, fax, or automated response system. A positive response allows the excavator to know whether all facility owners/operators have marked the requested area prior to the beginning of the excavation.

#### 4-10: Marking Multiple Facilities in the Same Trench



**Practice Statement:** Multiple facilities in the same trench are marked individually and with corridor markers.

**Practice Description:** In general, the number of lines marked on the surface equals the number of lines buried below. In circumstances where the total number of lines buried in the same trench by a single facility owner/operator may not be readily known, a corridor marker is used. The corridor marker indicates the width of the facility. (See Appendix B, "Uniform Color Code and Marking Guidelines.")<sup>20/</sup>

#### 4-11: Abandoned Facilities



**Practice Statement:** Information on abandoned facilities is provided when possible.

**Practice Description:** When the presence of an abandoned facility within an excavation site is known, an attempt is made to locate and mark the abandoned facility. When located or exposed, all abandoned facilities are treated as live facilities. Information regarding the presence or location of an abandoned facility may not be available because of updating or deletion of records. In addition, abandonment of an existing facility, damage to an abandoned facility, or limited or non-existing access points may render an abandoned line non-locatable. It should be emphasized that recommendation of this practice is not an endorsement of the maintenance of records for abandoned facilities.

#### 4-12: Locating Electromagnetically



**Practice Statement A:** When locating electromagnetically, active/conductive locating is preferable to passive/inductive locating.

**Practice Description:** The preferred method of actively applying a signal onto a facility is to use direct connection. Direct connection is the process of connecting a direct lead from the transmitter to the target facility and connecting a ground lead from the transmitter to a ground point to complete a circuit. This process provides the strongest signal on the line and is less likely to "bleed over" to adjacent facilities than other methods of applying a signal. This method allows a greater range of frequency and power output options. It is good practice to use the lowest frequency possible at the lowest power output possible to complete the locate. If direct connection is not possible, use of an induction clamp (coupler) is the most effective method of applying a locate signal onto the target conductor. This method is more limiting for the choices of frequency and power outputs than direct connection. Using an induction clamp is not as effective at transmitting a signal as direct connection, can only be used within certain frequency ranges, and must use a higher power output. The least-preferred method is induction or broadcast mode on a transmitter. This usually results in a weak signal that will "bleed over" to any conductor in the area.



**Practice Statement B:** When electromagnetic locating is not possible, radar-based technologies can be used.<sup>10/</sup>

**Practice Description:** In cases where non-conductive utilities cannot be located using electromagnetic means, radar-based methods such as ground penetrating radar and associated technologies can be used to determine the location of such utilities. It is important to note that these technologies are not applicable in all areas or conditions, because conductive soils and materials obscure radar signals. Users of these technologies should have the degree of knowledge and training required to operate the associated equipment and/or to interpret the results. Applicable radar frequencies range from 200 MHz to 900 MHz, where higher frequencies provide higher resolution but shallower depth of penetration.

#### 4-13: Facility Owner/Operator Identification



**Practice Statement:** The facility owner/operator is identified.

**Practice Description:** When feasible, the owner/operator of a facility is identified by markings at the time the facility is located. This practice facilitates a positive response for all facilities within the requested area. (See Appendix B, “Uniform Color Code and Marking Guidelines.”)

#### 4-14: Communication between Parties



**Practice Statement:** Communication is established between all parties.

**Practice Description:** One call centers, facility owners/operators, and excavators all have clearly defined processes to facilitate communication between all parties. If the complexity of a project or its duration is such that a clear and precise understanding of the excavation site is not easily conveyed in writing on a locate request, then a pre-location meeting is scheduled. This pre-location meeting is on-site to establish the scope of the excavation. Written agreements between the excavator(s) and the locator(s) include the following information:

- Date
- Name
- Company
- Contact numbers for all parties
- A list of the areas to be excavated
- A schedule for both marking and excavating the areas
- Any follow-up agreements that might be necessary

Any changes to the areas that are to be located are in writing and include all parties responsible for the excavation and marking of the excavation sites. Locators also schedule meetings if the complexity of the markings requires further explanation.

#### 4-15: Documentation of Work Performed



**Practice Statement:** Documentation of work performed on a locate is maintained.

**Practice Description:** A facility locator always documents what work was completed on a locate request. This assists in the locate process by requiring a locator to review what was located and then to verify that all facilities within the requested area were marked. Careful documentation helps ensure that there is an accurate record of the work performed by the locator and helps eliminate confusion over what work was requested by the excavator.

#### 4-16: Damage Investigation



**Practice Statement:** A damaged facility is investigated as soon as possible after occurrence of damage.

**Practice Description:** Anytime a damage occurs, a proper investigation is performed to determine not only the responsible party but also the root cause of the damage. The information gathered from damage investigations is essential in preventing future damages.

#### 4-17: Forecasting/Planning for Predictable Workload Fluctuations



**Practice Statement:** A plan is developed for managing unpredictable fluctuations.

**Practice Description:** Facility owners/operators and/or their representatives develop methods to sufficiently forecast and plan for future workloads so that ticket requests may be completed in a timely manner. This ensures that adequate personnel and equipment are available to complete all locate requests. Note: this practice does not limit the number of one call requests from excavators.

#### 4-18: Quality Assurance



**Practice Statement:** Underground facility owners/operators have a quality assurance program in place for monitoring the locating and marking of facilities.<sup>7/</sup>

**Practice Description:** The process of conducting audits for locates is a critical component to the protection of underground facilities. The recommended components listed below are assembled from multiple sources and are meant to provide general guidelines for auditing the work of locators.

##### Components:

- A: Conduct field audits and choose some locations to be audited/surveyed purely at random.
- B: Check accuracy to within, governed, contractual, and minimum tolerance levels.
- C: Measure timeliness, as defined by regulation/statute.
- D: Check completion of a request.
- E: Check evidence of accurate and proper communication.
- F: Check that proper documentation exists.
- G: Check that an audit/survey is documented.
- H: Communicate results to applicable personnel.
- I: Trace audits for trend analysis.
- J: Verify proper hook-up and grounding procedures where applicable.
- K: Verify the reference material used to document that the locate was up to date (electronic plans or paper plans).
- L: Verify that appropriate safety equipment and procedures were used by the locator.
- M: Verify that tools and equipment are in proper working order and properly calibrated.

##### References:

- Health Consultants Incorporated; Central Locate Services, LTD; Great Plains Locating, ATCO Gas; Utilquest

#### 4–19: Trenchless Excavation<sup>13/</sup>



**Practice Statement:** All stakeholders adhere to all best practices and the general guidelines stated in the following practice description prior to, during, and after any trenchless excavation (as applicable).

**Practice Description:** Locate in the area of the entrance pit the trenchless excavation path and the exit pit when trenchless excavation is being used. (For additional information, refer to Practice Statements 2–13 and 5–29.)

**References:**

- See Appendix D

#### 4–20: Locating and Marking in Navigable Waterways

##### A: Permanent Markers for Underwater Facilities<sup>12/</sup>



**Practice Statement:** Permanent markers are placed as close as practical at the entrance and exit points of facilities located underneath bodies of water where facilities are at risk of being damaged. For natural (and other) gas and hazardous liquids pipelines, these affected bodies of waters are “commercially navigable waterways” that have been defined in 49 CFR 195.450 for hazardous liquids pipelines as “waterways where a substantial likelihood of commercial navigation exists.”

**Practice Description:** Markers are used by underwater facility owners (e.g., cable, telecommunication, electric, water, sewer, and oil/gas pipelines, etc.) to indicate the presence of an underwater facility in the area. There are many excavating activities (e.g., dredging, bridge construction, anchors, directional boring, and other activities) that can damage these underwater facilities. The proper placement and maintenance of visible permanent markers raise the awareness of these facilities and reduce the likelihood of damage.

Markers for underwater facilities follow local, state, and federal laws and regulations. Facility type, name, and contact number of the facility operator are included on markers for all facility types. In some cases, the facility contact is the one call center. Markers include the words “Do Not Anchor or Dredge” and/or applicable warning language.

**Benefits:**

- By alerting excavators to the presence of underwater facilities, permanent shoreline markers provide additional protection to the excavators, facilities, and the public.

**References:**

- Tennessee Gas: 1995 Procedures, OPS: 49 CFR 192.707, Sunshine State One Call of Florida, State of California Code, State of Delaware Code, State of Alabama Code, State of Mississippi Code

**B: Temporary Markers for Underwater Facilities<sup>14/</sup>**

**Practice Statement:** Temporary markers are placed within the areas of proposed excavations as close as practical over facilities that are submerged in bodies of water where facilities are at risk of being damaged without impeding or creating additional hazards.

**Practice Description:** The technology used to locate and mark the submerged facility is dependent upon the size of the facility, depth of water, material composition of the floor, and the depth the facility is positioned in or on the floor of the body of water. Temporary markers such as buoys, poles, or PVC markers are used by underwater facility owners to indicate the presence of an underwater facility in the area. At times these markers may be supplemented with mapping, GPS coordinates, and/or fixed high-bank marks. There are many excavating activities, such as dredging, bridge construction, setting of anchors, and directional boring, that can damage underwater facilities. The proper placement of visible temporary markers raises the awareness of these facilities and reduces likelihood of damage. Communication between stakeholders is initiated through the one call center to reduce potential conflicts. It is critical for stakeholders to maintain communication throughout the excavation to ensure the safe and successful completion of the project. Placement and removal of temporary markers for underwater facilities follow local, state, and federal laws and regulations.

**Benefits:**

By alerting excavators to the presence of underwater facilities, temporary markers provide additional protection to excavators, facilities, and the public.

**References:**

- Sunshine State One Call of Florida, State of California Code, State of Delaware Code, State of Alabama Code, State of Mississippi Code

**4-21: Service Lines<sup>34/</sup>**

**Practice Statement:** A service line is marked in response to a locate request to the operator who uses the service line to pursue a business that derives revenue by providing a product or service to an end-use customer via the service line. A service line is marked in response to a locate request to a governmental entity that provides a product or service to an end-use customer via the service line.

**Practice Description:** A service line is a type of underground facility that is connected to a main facility. The service line is used by the following entities:

- An operator who provides a product or service within a right-of-way, an easement, or an allowed access to or through private property while pursuing a business that generates revenue by providing a product or service to an end-use customer (other than another operator of like kind or themselves)
- A governmental entity that provides a product or service via that service line.

The operator or the governmental entity locates and marks these service lines within the bounds of the locate request up to either 1) the point of their operational responsibility, 2) the point the service line enters a building, or 3) where the access to locate the line terminates, as designated by the prevailing law.

**References:**

- South Dakota Attorney General's official opinion 8/11/08
- Minnesota DPS Rule Ch 7560 – 5/31/05
- Colorado appellate court case: Wycon Construction Co. v. Wheat Ridge Sanitation District, 870 P.2d 496 (Ct. App. Col. 1994)
- Leon County, FL, County Court Case No. 03-SC-6827, Mitchell Properties, Ltd. V. Cornerstone of North Florida, Inc. v. City of Tallahassee

- Oregon PUC Ruling 5/1/98
- State One Calls laws: AZ, GA, MN, OH, PA

#### 4–22: Marking Newly Installed Facilities<sup>42/</sup>



**Practice Statement:** Facility operators ensure that new facilities in areas with continuing excavation activity are marked upon installation to indicate their presence.

**Practice Description:** In areas of continuing excavation, newly installed facilities can be damaged and safety can be compromised if the facilities are not marked. Marking facilities upon installation gives notice to other excavators of the newly installed facilities that may not otherwise be marked in response to a notice of intent to excavate.

**References:**

- CenterPoint Energy/Minnesota, Michels Construction, WE Energies/Wisconsin

## Excavation

 One Call Center
  Facility Owner
  Excavator
  Locator
  Project Owner
  Designer

## 5-1: One Call Facility Locate Request



**Practice Statement:** The excavator requests the location of underground facilities at each site by notifying the facility owner/operator through the one call center. Unless otherwise specified in state/provincial law, the excavator calls the one call center at least two working days and no more than ten working days prior to beginning excavation.

**Practice Description:** Currently 50 states and 5 Canadian provinces have one call legislation and/or established one call centers recognizing that excavation performed without prior notification poses a risk to public safety, excavators, and the environment, and can disrupt vital services provided by facility operators. Increased participation in this one call system provides for improved communication between excavators and facility operators necessary to reduce damage.

**Reference:**

- Existing state laws, including Ohio and West Virginia

5-2: White Lining<sup>67/</sup>

**Practice Statement:** When the excavation site cannot be clearly and adequately identified on the locate ticket, the excavator designates the route and/or area to be excavated using white premarking, either onsite or electronically (when available through the one call center), prior to or during the request for the locate ticket.

**Practice Description:** The route of the excavation is marked with white paint, flags, stakes, lines, polygons, or a combination of these to outline the dig site prior to or during notification to the one call center and before the locator arrives on the job. Electronic white lining when available provides an alternative method where excavators may indicate their defined dig area visually by electronic data entry (lines or polygons) without the need for a physical site visit. The technology allows the excavator to identify for the locate technician a clear delineation of their proposed excavation area. Premarking allows the excavators to accurately communicate to the one call center, facility owners/operators, or their locator where excavation is to occur. The 1997 safety study “Protecting Public Safety through Excavation Damage Prevention” by the NTSB reached the conclusion that premarking is a practice that helps prevent excavation damage. Maine was one of the first states to have mandatory premarking for non-emergency excavations. Connecticut also adopted a premarking requirement; however, the law provides for face-to-face meetings between operators and excavators on projects that are too large for or not conducive to premarking. Facility owners/operators can avoid unnecessary work created when locating facilities that are not associated with planned excavation. (See Appendix B for additional practice information)

**References:**

- Existing state laws, including California, Missouri, New Jersey, and others
- Lambert’s Cable Construction, LLC and UtiliQuest, LLC; Verizon Fios drop placement process in VA, MD, and DC
- One Call Concepts; Internet Ticket Processing (ITIC)—excavation polygon feature to define entire proposed excavation areas
- Virginia Pilot Project; Phase I—Electronic White Lining Study

### 5–3: Locate Reference Number



**Practice Statement:** The excavator receives and maintains a reference number from the one call center that verifies that the locate was requested.

**Practice Description:** All calls from excavators processed by the one call center receive a unique message reference number, which is contained on all locate request messages. The excavator records this number; it is proof of notification to the members. The computer-generated request identifies the date, time, and sequence number of the locate request. Each locate request ticket (notification) is assigned a unique number with that one call center, the requestor, and the facility owner/operator. This number distinguishes this ticket from all other tickets so that it can be archived and retrieved upon request to provide the details of that request only.

**References:**

- Existing state laws, all 50 states have one call centers and/or state statues
- Existing operating procedures from various state one call centers

### 5–4: Pre-excavation Meeting



**Practice Statement:** When practical, the excavator requests a meeting with the facility locator at the job site prior to marking the facility locations. Such pre-job meetings are important for major, or unusual, excavations.

**Practice Description:** The meeting facilitates communications, coordinates the marking with actual excavation, and ensures identification of high-priority facilities. An on-site pre-excavation meeting between the excavator, facility owners/operators, and locators (where applicable) is recommended on major or large projects. This includes projects such as road, sewer, water, or other projects that cover a large area, that progress from one area to the next, or that are located near critical or high-priority facilities. Such facilities include, but are not limited to, high-pressure gas, high-voltage electric, fiber-optic communication, and major pipe or water lines.

**References:**

- Existing insurance carrier guidelines
- Existing practice among excavators, including Pauley Construction and W.F. Wilson & Sons, Inc.

### 5–5: Facility Relocations



**Practice Statement:** The excavator coordinates work that requires temporary or permanent interruption of a facility owner/operator's service with the affected facility owner/operator in all cases.

**Practice Description:** Any temporary or permanent interruption requires the active participation by the facility owner/operator and the excavator to ensure protection of facilities through a joint preplanning meeting or conference call. One call centers note on the ticket any special contractor requests for a joint meeting that require the facility owner/operator to initiate the process.

**Reference:**

- Existing practice among one call centers

## 5-6: Separate Locate Requests



**Practice Statement:** Every excavator on the job has a separate one call reference number before excavating.

**Practice Description:** There are often several excavators on a job site performing work. The construction schedule may dictate different types of work requiring excavation from different specialty contractors simultaneously. In these situations, it is imperative for each excavator to obtain a one call reference number before excavation to ensure that the specific areas have been appropriately marked by any affected underground facility owner/operator.

**Reference:**

- Existing state laws, including Ohio, Kansas, Michigan, Maryland, Illinois, and others

## 5-7: One Call Access (24/7)



**Practice Statement:** The excavator has access to a one call center 24 hours per day, 7 days a week.

**Practice Description:** Utilities service the public needs 24 × 7 and thus should be protected during that same time. Certain conditions may exist that require excavators to work during off-hours (city/road congestion, off-peak utility service hours). Although most excavators are on the job site during regular work hours, they need to be able to call in future work locations after 5:00 p.m. This allows them more flexibility to schedule work and to avoid peak hours of locate requests at the one call center.

**Reference:**

Existing states laws, including Texas, Idaho, Minnesota, Pennsylvania, and others (25 participating states or one call centers with 24/7 access)

## 5-8: Positive Response



**Practice Statement:** The underground facility owner/operator either 1) identifies for the excavator the facility's tolerance zone at the work site by marking, flagging, or other acceptable methods; or 2) notifies the excavator that no conflict situation exists. This takes place after the one call center notifies the underground facility owner/operator of the planned excavation and within the time specified by state/provincial law.

**Practice Description:** If a facility owner/operator determines that the excavation or demolition is not near any of its existing underground facilities, it notifies the excavator that no conflict exists and that the excavation or demolition area is "clear." This notification by the facility owner/operator to the excavator may be provided in any reasonable manner including, but not limited to face-to-face communications; phone or phone message, facsimile or other electronic means; posting at the excavation or demolition area; or marking the excavation or demolition area. If an excavator has knowledge of the existence of an underground facility and has received an "all clear," a prudent excavator will attempt to communicate that a conflict does indeed exist, and the locator will make marking these facilities a priority before excavation begins. Better communication between the excavator and the facility owner/operator is required as an area of excavation becomes more crowded with new underground facilities.

"Positive response" is a term used to describe the two types of action taken by a facility owner/operator after it receives notification of intent to excavate. The facility owner/operator must 1) mark its underground facilities with stakes, paint, or flags; or 2) notify the excavator that the facility owner/operator has no underground facilities in the area of excavation. This process allows the excavator to begin work in a timely manner.



When the excavator makes the request to the one call center, the excavator is told which facility owners/operators will be notified. The excavator logs these facilities on a job sheet and identifies which facility owner/operators have responded by marking and which have cleared the area. When a facility owner/operator does not respond by marking or clearing, it may indicate that the facility owner/operator did not receive a locate notice or that the one call center's contact information for that facility owner/operator may be incorrect, incomplete, or corrupt (which could result in calamity).

When the excavator has obtained all required information, the excavation can commence with confidence that the safety of the work crew and the public at large has been considered.

**References:**

- Existing state laws, including California, Maryland, Nevada, and others
- Existing operating procedure for various one call centers (31 participating states or one call centers)

### 5–9: Facility Owner/Operator Failure to Respond



**Practice Statement:** If the facility owner/operator fails to respond to the excavator's timely request for a locate (e.g., within the time specified by state/provincial requirements) or if the facility owner/operator notifies the excavator that the underground facility cannot be marked within the time frame and a mutually agreeable date for marking cannot be arrived at, then the excavator re-calls the one call center. However, this does not preclude the excavator from continuing work on the project. The excavator may proceed with excavation at the end of two working days, unless otherwise specified in state/provincial law, provided the excavator exercises due care in all endeavors.

**Practice Description:** The facility owner/ operator and the excavator partner together to ensure that facilities are marked in an acceptable time frame to allow for underground facility protection.

**Reference:**

- Existing state laws, including Ohio, Kansas, South Carolina, Michigan, and others

### 5–10: Locate Verification



**Practice Statement:** Prior to excavation, excavators verify that they are at the correct location, verify locate markings and, to the best of their ability, check for unmarked facilities.

**Practice Description:** Upon arrival at the excavation site and prior to beginning the excavation, an excavator does the following:

- Verifies that the dig site matches the one call request and is timely
- Verifies that all facilities have been marked and reviews color codes if in doubt
- Verifies all service feeds from buildings and homes
- Checks for any visible signs of underground facilities, such as pedestals, risers, meters, and new trench lines
- Checks for any facilities that are not members of the one call center and contact someone to get them located.

Use of a pre-excavation checklist is recommended by insurers and practiced by responsible excavating contractors.

**Reference:**

- Existing practice by excavators, including Pauley Construction and W.F. Wilson & Sons, Inc.

## 5–11: Documentation of Marks



**Practice Statement:** An excavator uses dated pictures, videos, or sketches with distance from markings to fixed objects recorded, to document the actual placement of markings.

**Practice Description:** In most situations when underground facilities are not properly marked, excavators have no way of knowing where underground utilities are located. If locate markings are adequately documented through the use of photographs, video tape, or sketches before excavation work begins, it is easier to resolve disputes if an underground facility is damaged as a result of improper marking, failure to mark, or markings that have been moved, removed, or covered. It is important for excavators and locators to document the location of markings before excavation work begins. The primary purpose of this best practice is to avoid unnecessary litigation and expensive legal fees for all parties involved.

**Reference:**

- Existing practice by excavators, including Pauley Construction

## 5–12: Work Site Review with Company Personnel



**Practice Statement:** Prior to starting work, the excavator reviews the location of underground facilities with site personnel.

**Practice Description:** Sharing information and safety issues during an on-site meeting between the excavator and the excavating crews helps avoid confusion and needless damage to underground facilities.

**Reference:**

- Existing practice by excavators, including Pauley Construction, A&L Underground, and W.F. Wilson & Sons, Inc.

## 5–13: One Call Reference at Site<sup>59/</sup>



**Practice Statement:** Except in case of an emergency, the excavator at each job site has available a complete description of the dig site, a list of the facility owner members impacted at that dig site as identified by the one call center, and the one call center ticket number.

**Practice Description:** The availability of locate request details on site is useful because excavators can easily access information about the location and extent of work, the valid start time, and the list of operators notified. The documentation also provides an excavator with appropriate information for daily tailgate meetings for crews; provides quick references for excavation equipment operators; and facilitates communications between the excavator and the one call center with respect to that particular locate request, should it become necessary. When multiple crews are working on the same project at separate locations or when different employers have crews working at the same location, each crew has the information.

**References:**

- Existing state regulations including Michigan DOT

## 5–14: Contact Names and Numbers



**Practice Statement:** The excavator’s designated competent person at each job site has access to the names and phone numbers of all facility owner/operator contacts and the one call center.

**Practice Description:** Situations arise on the job site that require immediate notification of the facility owner/operator, one call center, or local emergency personnel. To avoid costly delays, the excavator ensures that the designated job site personnel have all appropriate names and phone numbers. If telephone communication is unavailable, radio communication to the “home office” is available so that timely notification can be made. The “home office” also has immediate access to all appropriate names and telephone numbers.

**Reference:**

- Existing state regulations, including Michigan DOT

## 5–15: Facility Avoidance



**Practice Statement:** The excavator uses reasonable care to avoid damaging underground facilities. The excavator plans the excavation so as to avoid damage or to minimize interference with the underground facilities in or near the work area.

**Practice Description:** Foremost on any construction project is safety. Excavators using caution around underground facilities significantly contribute to safe excavation of existing facilities.

**Reference:**

- Existing state laws, including Kansas, Ohio, West Virginia, and others

## 5–16: Federal and State Regulations



**Practice Statement:** The excavator complies with all applicable federal and state/provincial safety regulations, and, when required, provides training as it relates to the protection of underground facilities.

**Practice Description:** Although most existing state/provincial damage prevention legislation does not include reference to federal and state/provincial regulations, it is important to include reference to worker safety and training in the best practices. Excavators are required to comply with federal and state/provincial occupational safety and health requirements to protect employees from injury and illness. These regulations include reference to training each employee to recognize and avoid unsafe conditions in the work environment and to control or eliminate any hazards or exposures to illness or injury. Therefore, the excavator’s crew, as part of its safety training, is informed of the best practices and regulations applicable to the protection of underground facilities.

**References:**

- Required by federal and state law
- Existing practice by excavators and facility owners/operators

## 5–17: Marking Preservation



**Practice Statement:** The excavator protects and preserves the staking, marking, or other designation of underground facilities until no longer required for proper and safe excavation. The excavator stops excavating and notifies the one call center for re-marks if any facility mark is removed or is no longer visible.

**Practice Description:** During long, complex projects, the marks for underground facilities may need to be in place far longer than the locating method is durable. Painting, staking, and other marking techniques last only as long as the weather and other variables allow. When a mark is no longer visible, but work continues around the facility, the excavator requests a re-mark to ensure the protection of the facility.

**Reference:**

- Existing state law, including Ohio

## 5–18: Excavation Observer



**Practice Statement:** The excavator has an observer to assist the equipment operator when operating excavation equipment around known underground facilities.

**Practice Description:** The excavator designates a worker (an observer) who watches the excavation activity and warns the equipment operator while excavating around a utility to prevent damaging that buried facility.

**References:**

- Existing state law, including Ohio
- Existing practice among large facility owners/operators, including Southern Natural Gas, Bell South, and Columbia Gas

## 5–19: Excavation Tolerance Zone



**Practice Statement:** The excavator observes a tolerance zone that is comprised of the width of the facility plus 18 in. on either side of the outside edge of the underground facility on a horizontal plane. This practice is not intended to preempt any existing state/provincial requirements that currently specify a tolerance zone of more than 18 in.

**Practice Description:** (See Practice Statement 5–20.)

**References:**

- Existing state laws, including New Mexico, Pennsylvania, South Dakota, and others
- Telecommunications Industry Association and Electronic Industry Association (TIA/EIA), “Standard for Physical Location and Protection of Below-Ground Fiber Optic Cable Plant” (ANSI/TIA/EIA-590-A-1996)
- American Public Works Association (APWA), “Guidelines for Uniform Temporary Marking of Underground Facilities”

## 5–20: Excavation within Tolerance Zone



**Practice Statement:** When excavation is to take place within the specified tolerance zone, the excavator exercises such reasonable care as may be necessary for the protection of any underground facility in or near the excavation area. Methods to consider, based on certain climate or geographical conditions, include hand digging when practical (pot holing), soft digging, vacuum excavation methods, pneumatic hand tools, other mechanical methods with the approval of the facility owner/operator, or other technical methods that may be developed. Hand digging and non-invasive methods are not required for pavement removal.

**Practice Description:** Safe, prudent, non-invasive methods that require the excavator to manually determine the actual location of a facility are considered “safe excavation practices” in a majority of state/provincial laws (38 states). A majority of states outline safe excavation practices to include hand digging or pot holing (16 states). Some states specifically allow for the use of power excavating equipment for the removal of pavement. Each state/province must take differing geologic conditions and weather related factors into consideration when recommending types of excavation within the tolerance zone.

**Reference:**

- Existing state laws, including Arizona, New Hampshire, Pennsylvania, and others

## 5–21: Mismarked Facilities



**Practice Statement:** The excavator notifies the facility owner/ operator directly or through the one call center if an underground facility is not found where one has been marked or if an unmarked underground facility is found. Following this notification, the excavator may continue work if the excavation can be performed without damaging the facility, unless specified otherwise in state/provincial law.

**Practice Description:** When an excavator finds an unmarked or inaccurately marked facility, excavation stops in the vicinity of the facility and notification takes place. If excavation continues, the excavator plans the excavation to avoid damage and interference with other facilities and protects facilities from damage.

**References:**

- Existing state/local laws, including Arizona
- Existing practice among excavators, including W.F. Wilson & Sons, Inc.

## 5–22: Exposed Facility Protection



**Practice Statement:** Excavators support and protect exposed underground facilities from damage.

**Practice Description:** Protecting exposed underground facilities is as important as preventing damage to the facility when digging around the utility. Protecting exposed underground facilities helps ensure that the utility is not damaged and, at the same time, protects employees working in the vicinity of the exposed facility. Exposed facilities can shift, separate, or be damaged when they are no longer supported or protected by the soil around them. Excavators support or brace exposed facilities and protect them from moving or shifting, which could result in damage to the facility. This can be accomplished in different ways; for example, by shoring the facility from below or by providing a timber support with hangers across the top of an excavation to ensure that the facility does not move or bend. In addition, workers are instructed to not climb on, strike, or attempt to move exposed facilities that could damage protective coatings, bend conduit, separate pipe joints, damage cable insulation, damage fiber optics, or in some way affect the integrity of the facility. The Occupational Safety and Health Administration (OSHA) also has addressed this issue in Subpart P—Excavation Standard 29 CFR 1926.651(b)(4), which states “While the excavation is open, underground installations shall be protected, supported, or removed as necessary to safeguard employees.” For example, an unsupported sewer main could shift, causing the pipe joints to separate, which could result in the trench where employees are working to flood, endangering the safety of employees.

**Reference:**

- Existing state/local laws, including Washington, DC, Idaho, Utah, Arizona, Virginia, Pennsylvania, New York, and others

## 5–23: Locate Request Updates



**Practice Statement:** The excavator calls the one call center to refresh the ticket when excavation continues past the life of the ticket (sometimes, but not always, defined by state/provincial law). This recognizes that it is a best practice to define ticket life. If not currently defined in state/provincial law, ticket life is ideally 10 working days but does not exceed 20 working days. Original locate request tickets are generated so that the minimum number of locate request updates are necessary for the duration of a project. After all the excavation covered by a locate request is completed, no additional locate request updates are generated. Communication between excavation project planners, field personnel, and clerical personnel is essential in accomplishing this task.<sup>36/</sup>

**Practice Description:** Refreshing the ticket recognizes that markings are temporary and provides notification to facility owners/operators of ongoing excavation when a job is started but not completed as planned. Any excavation not begun during the life of the ticket is recalled to the one call center. Any excavation that covers a large area and will progress from one area to the next over a period of time is broken into segments when notifying the one call center in order to coordinate the marking with actual excavation. The possibility exists that new facilities have been installed in the area where the excavation is to be conducted after the original notification and marking. This practice also helps in situations where multiple excavators are working in the same area at essentially the same time. An example of when this can occur is when two facility owners, such as a cable television company and a telephone company, are planning to serve a new section of a subdivision. In their pre-planning process, they see a vacant space in the right-of-way to place their new facility. Each excavator (internal or external) calls the one call center for locates and each facility owner/operator comes and marks their respective facilities indicating that nothing exists. For one reason or another, one of the excavators gets delayed and does not start construction

as planned, and when returning to the job site to place the new facility, finds new lines have been installed in the previously vacant space. Many facility owners/operators do not perform their own locates and utilize the services of a contracted facility locator. These contracted facility locators may not be aware of work planned in the near future. By excavators refreshing the locate ticket, the contract locator has another opportunity to identify newly placed facilities. This practice also gives the facility owner/operator another chance to identify the location of their facilities and to avoid possible damage and disruption of service if something was marked incorrectly or missed on a previous locate. Excellent planning, generation, and updating of tickets enhance safety and reduce the unnecessary use of locate resources.<sup>37/</sup>

**Reference:**

- Existing state laws that specify 10 working days include Kansas, Ohio, Wisconsin, Pennsylvania, and Texas. Existing state laws that specify 15 working days include Virginia and Tennessee.
- Existing practices by Progress Energy, Duke Energy of Houston, Texas, and Arizona Blue Stake, Inc.

### 5–24: Facility Damage Notification



**Practice Statement:** An excavator discovering or causing damage to underground facilities notifies the facility owner/operator and the one call center. All breaks, leaks, nicks, dents, gouges, grooves, or other damages to facility lines, conduits, coatings, or cathodic protection are reported.

**Practice Description:** A majority of states require notification for damage or substantial weakening of an underground facility (27 states). The possibility of facility failure or endangerment of the surrounding population dramatically increases when a facility has been damaged. Although the facility may not immediately fail, the underground facility owner/operator is provided the opportunity to inspect the damage and make appropriate repairs.

**Reference:**

- Existing state laws, including Arkansas, Idaho, Maryland, and others

### 5–25: Notification of Emergency Personnel



**Practice Statement:** If the damage results in the escape of any flammable, toxic, or corrosive gas or liquid or endangers life, health, or property, the excavator responsible immediately notifies 911 and the facility owner/operator.<sup>3/</sup> The excavator takes reasonable measures to protect everyone in immediate danger, the general public, property, and the environment until the facility owner/operator or emergency responders arrive and complete their assessment.<sup>4/</sup>

**Practice Description:** This practice is already required by many of the states' one call legislation. This practice minimizes the danger to life, health, or property by notifying the proper authorities to handle the emergency situation. In these situations, local authorities are able to evacuate as appropriate and command substantial resources unavailable to the excavator or underground facility owner/operator. The excavator takes reasonable measures based on their knowledge, training, resources, experience, and understanding of the situation to protect themselves, people, property, and the environment until help arrives. The excavator responsible remains on-site to convey any pertinent information to responders that may help them to safely mitigate the situation.<sup>4/</sup>

**Reference:**

- Existing state laws, including Kansas, Ohio, Oregon, and Minnesota

## 5-26: Emergency Excavation



**Practice Statement:** In the case of an emergency excavation, maintenance or repairs may be made immediately, provided that the excavator notifies the one call center and facility owner/operator as soon as reasonably possible. This includes situations that involve danger to life, health, or property or that require immediate correction in order to continue the operation of or ensure the continuity of public utility service or public transportation.

**Practice Description:** This practice allows excavation to begin immediately to restore service or to stop a hazardous situation from getting worse in the case of a gas or pipeline leak, cut telephone cable, or other facility damage.

**Reference:**

- Existing state laws, including Colorado, Nevada, West Virginia, and others (49 participating states or one calls)

## 5-27: Backfilling



**Practice Statement:** The excavator protects all facilities from damage when backfilling an excavation. Trash, debris, coiled wire, or other material that could damage existing facilities or interfere with the accuracy of future locates are not buried in the excavation.

**Practice Description:** Extra caution must be taken to remove large rocks, sharp objects, and large chunks of hard-packed clay or dirt. No trash or pieces of abandoned lines are backfilled into the trench. This helps prevent inadvertent damage to the facility during the backfill process.

**References:**

- Michigan DOT specification
- Existing insurance carrier guidelines

## 5-28: As-built Documentation



**Practice Statement:** Contractors installing underground facilities notify the facility owner/operator if the actual placement is different from expected placement.

**Practice Description:** For a facility owner/operator to maintain accurate records of the location of their facilities, it is critical that the contractor installing the new facility be required to notify the facility owner/operator of deviations to the planned installation. Some facility owners/operators do not require a full-time inspector and use a sampling process to ensure that a new facility is correctly installed in compliance to specifications. When this occurs, it becomes much more critical for the contractor to notify the facility owner/operator of changes. For example, it is common for the contractor to make adjustments in the location of the new facility when rocks or other underground obstructions are encountered or when the location of the new facility conflicts with another existing underground facility. This change in plan can represent changes in horizontal or vertical distances from the specified plans. The facility owner/operator establishes standards that require notification if a deviation is beyond specified tolerances, such as changes in depth of 6 in. or more and lateral measurement changes of greater than 1 ft. When these changes to the expected location are communicated to the facility owner/operator, it is the owner/operator's responsibility to take appropriate action to update their records so that an accurate locate can be conducted in the future.

**Reference:**

- Existing operating practice among facility operators, including Ameritech, Sprint, Columbia Gas, and others



### 5–29: Trenchless Excavation<sup>13/</sup>



**Practice Statement:** All stakeholders comply with all best practices and the following general guidelines prior to, during, and after any trenchless excavation (as applicable).

**Practice Description:**

- The excavator requests the location of underground facilities at the entrance pit, trenchless excavation path, and the exit pit by notifying the facility owner/operator through the one call center.
- The trenchless equipment operator performs a site inspection, walking the trenchless excavation path prior to commencing work, and has a good understanding of the job.
- The trenchless excavation operator confirms and maintains the path and minimum clearances established by the project owner and design engineer by tracking and recording the path of the trenchless excavation until complete. Means of tracking trenchless excavations include electronic locating/guidance devices, pipe lasers, water levels, visual inspection, etc.
- When existing facilities are known to be present but cannot be potholed as a result of local conditions, the facility owner and the excavator meet to discuss how to safely proceed with the excavation.
- The excavator stops the trenchless excavation operations if an abnormal condition, unknown substructure, or other hidden hazard is encountered. The excavator proceeds safely only after making positive identification. (Refer to Practice Statements 2–13 and 4–19 for additional information.)

**References:**

See Appendix D

### 5–30: Emergency Coordination with Adjacent Facilities<sup>16/</sup>



**Practice Statement:** Emergency response planning includes coordination with emergency responders and other aboveground and/or underground infrastructure facility owner/operators identified by the Incident Commander through the Incident Command System/Unified Command (ICS/UC) during an emergency.

**Practice Description:** During emergency situations, there are many stakeholders involved: excavators, locators, owner/operators, first responders, one call centers, and the general public. Any actions taken by one stakeholder could adversely affect other stakeholders. Accordingly, emergency planning and response are coordinated.

**References:**

- XCEL Energy, Minnesota
- Public Service Electric and Gas, Newark, New Jersey, Gas Emergency Procedure Manual

**5–31: No Charge for Providing Underground Facility Locations<sup>23/</sup>**

**Practice Statement:** Upon notification by one call centers, locations of underground facilities are provided by operators at no cost to excavators.

**Practice Description:** It is the basic underpinning of the call-before-you-dig process that persons involved in excavation activities receive facility locates at no charge when they contact their local one call center to give notice of intent to excavate. This service is critical to maintaining the communication between operators and excavators. Call-before-you-dig education and marketing campaigns, such as 811 and those promoted by one call centers and associated industries, advise persons involved in excavation activities, including the public, homeowners, and professional excavators, that the service is provided by facility operators at no charge to the person providing the notice of intent to excavate.

**References:**

Minnesota state statutes, Alberta pipeline

**5–32: Vacuum Excavation<sup>39/</sup>**

**Practice Statement:** Vacuum excavation, when used appropriately, is an efficient, safe, and effective alternative to hand digging within the designated underground facility tolerance zone. Use of equipment also follows state/provincial laws and/or local ordinances.

**Practice Description:** The safe exposure of underground facilities within the tolerance zone is essential to damage prevention. Site conditions may make the use of hand tools to expose underground facilities difficult or even impractical. Vacuum excavation is often an appropriate alternative. Locates must be obtained prior to the commencement of work (see Practice Statement 5–1). Many underground facility owners/operators have specific criteria for safe excavation/exposure practices around their facilities. Some underground facility owners/operators accept vacuum excavation as equivalent to hand excavation for exposing their facilities, and others have restrictions on its use. Vacuum excavation is an appropriate method of excavating safely around underground facilities provided that the equipment

- has been specifically designed and built for this purpose;
- is operated by a worker trained and experienced in its operation;
- is operated in accordance with practices that provide appropriate levels of worker and public safety and prevent damage to buried facilities; and
- is used in compliance with state/provincial laws and/or local ordinances.

**References:**

- Existing state laws including South Carolina and North Carolina
- B.R.S., Inc.

**5–33: Facility Owner Provides a Monitor During Excavation<sup>64/</sup>**

**Practice Statement:** If a facility owner/operator considers it necessary to be on site during excavation activities to work with the excavator in protecting their existing facilities, the facility owner/operator makes arrangements with the excavator to be present during those excavation activities within the time specified by state/provincial law.







**Practice Description:** The facility owner/operator may determine it necessary to be on site during excavation activities taking place near their facilities to help protect them. A facility owner/operator has access to information and resources that may not be available to the excavator. This practice should be considered in conjunction with Practice Statement 2–4: Utility Coordination.

**References:**

- North Carolina, Delaware, Florida, Ohio, and California regulations

LEFT BLANK INTENTIONALLY

## Mapping

 One Call Center
  Facility Owner
  Excavator
  Locator
  Project Owner
  Designer

The Mapping Team chose to look at mapping practices from the viewpoint of the different areas represented by team members. From this viewpoint, the best practices for mapping can be listed in five distinct areas: One Call Center, Locator, Excavator, Facility Owner/Operator, and Project Owner. By consensus of the Mapping Task Team, all of the findings listed below are best practices.

## One Call Center

A one call center uses an electronic mapping database system that includes the following:

### 6-1: Land Base Accuracy



**Practice Statement:** The land base is accurate.

**Practice Description:** The land base is the most precise geographical information available to the one call center. The one call centers in these states follow this practice: Arizona, Minnesota, North Carolina, Texas, and Wisconsin.

### 6-2: Latitude/Longitude



**Practice Statement:** The land base and database use latitude/longitude (Lat/Long) coordinates.

**Practice Description:** The land base and database can produce Lat/Long information based upon street address, street/road name, intersection, milepost marker, etc. It also is possible to determine the street address, street/road name, intersection, or milepost based upon Lat/Long information. The translation of Lat/Long information is automatic. A map point (i.e., a rural area not in the immediate vicinity of a road or known map landmark) can be identified by Lat/Long information. The one call centers in these states follow this practice: Ohio, South Dakota, New Jersey, Missouri, and Tennessee.

### 6-3: Up-to-date Land Base Information



**Practice Statement:** The land base is up-to-date.

**Practice Description:** The land base is kept up-to-date, and a process is in place that periodically adds new street information, name changes, aliases, and municipal boundaries. The one call centers in these states follow this practice: Arizona, Ohio, and New Jersey.

### 6-4: Timely Database Updating



**Practice Statement:** The database is updated by information from facility owners/operators.

**Practice Description:** The database is promptly updated as information is provided or becomes available from the facility owner/operator. The system can accept information in standard file format with minimal human intervention. The one call centers in these states follow this practice: Arizona, North Carolina, Ohio, New Jersey, and Wisconsin.

### 6-5: Electronic Mapping Location Area



**Practice Statement:** The electronic mapping system can produce a ticket for the smallest practical geographical area.

**Practice Description:** The electronic mapping system can produce a ticket for the smallest practical geographical area. The one call centers in these states follow this practice: Arizona, Tennessee, Minnesota, Oregon, and Wisconsin.

### 6-6: Availability



**Practice Statement:** The land base is available to the public.

**Practice Description:** The land base is available to the public for the identification of the excavation area. The land base and database are available to the one call center membership for the update of member database information. The one call centers in these states follow this practice: North Carolina, Ohio, and South Dakota.

## Locator

Locators use maps to help find the excavation site and to help determine the general location of the buried facility.

### 6-7: Training



**Practice Statement:** Locators are trained in map reading and symbology.

**Practice Description:** Locators are trained in map reading and symbology to help determine the location of the buried facility. The following association trains its members to carry out this practice: National Utility Locating Contractors Association (NULCA).

### 6-8: Discrepancies



**Practice Statement:** The locator provides precise facility location to the facility owner/operator when there is a discrepancy.

**Practice Description:** The locator provides to the facility owner/operator the most precise facility location information obtained from a locate when there is a discrepancy.

References:

- Arizona Blue Stake law

### 6-9: Feedback



**Practice Statement:** The locator supplies feedback to the one call center.

**Practice Description:** The locator provides to the one call center feedback on land base mapping and location discrepancies. The following states carry out this practice: Ohio, Tennessee, and North Carolina.

## Excavator

### 6–10: Accuracy of Location Information



**Practice Statement:** The excavator provides accurate location information to the one call center.

**Practice Description:** The excavator takes responsibility for giving accurate location information to the one call center. This information includes a street address, street intersection, legal description, or other appropriately formatted information, and latitude/longitude (if feasible).

### 6–11: Excavation Area Details



**Practice Statement:** The excavator provides to the one call center basic attributes about the excavation area.

**Practice Description:** The excavator provides details about the excavation area location, such as starting and ending points, the side of the property (north, south, east, west, front, back, rear, sides, etc.), and the side of the street. If the excavator cannot meet the above criteria, the excavator directly coordinates with the one call center to establish the excavation area.

References:

- Michaels Pipeline Company, Brownsville, Wisconsin
- Hooper Corporation, Pewaukee, Wisconsin
- Intercon Construction, Madison, Wisconsin

## Facility Owner/Operator

### 6–12: Mapping Data



**Practice Statement:** The facility owner/operator provides mapping data to the one call center.

**Practice Description:** The facility owner/operator provides the one call center with data that will allow efficient and accurate notification of excavation activities near the facility owner/operators' infrastructure. Facility owners/operators in all mandatory one call states follow this practice.

### 6–13: Access to Mapping Data



**Practice Statement:** The facility owner/operator provides mapping data access.

**Practice Description:** The facility owner/operator provides access to a mapping system that can be used by both the locator and the facility owner/operator. These facility owners/operators follow this practice: Atlanta Gas Light, Sprint Long Distance, AT&T, Questar Regulated Services.

### 6–14: Mapping Standards



**Practice Statement:** The facility owner/operator adheres to mapping standards.

**Practice Description:** The facility owner/operator requires the designer to adhere to the facility owner/operator's mapping standards. These facility owners/operators follow this practice: AT&T, Sprint Long Distance.

## 6–15: Quality of Information



**Practice Statement:** The facility owner/operator provides consistent, current information to the one call center.

**Practice Description:** The facility owner/operator provides consistent, current information to the one call center for the proper receipt of ticket notification. Basic information includes latitude and longitude and pertains to a physical attribute where available, such as a milepost marker. This facility owner/operator follows this practice: Sprint Long Distance.

## 6–16: Information Capture



**Practice Statement:** The facility owner/operator collects detailed mapping information.

**Practice Description:** The facility owner/operator captures through the electronic database the following information to ensure project safety in the plan, design, construction, documentation, location, and maintenance of their longitudinal utility.

- Any new construction that was entered at the time of installation
- The location of abandoned or sold facilities
- Engineering stationing and milepost/marker post location (with latitude and longitude) using common mapping coordinate systems that allow conversion to latitude and longitude
- Alignment of the utility with engineering stationing at each running line change or point of inflection (PI) including signs and markers
- Bridges, culverts, and rivers
- All road crossings; overhead viaducts, and underpasses, including name of the street (public or private); and mile-marker/marker-post designation
- Small-scale maps showing the overall utility route
- Physical characteristics and attributes of the system, such as pedestal, pole, transformer, meter number, anode bed, size, material, product, and pressure
- The number of utility lines or conduits owned by the facility owner/operator in a corridor or the size of the duct package bank (universally a general practice of major pipeline and long-distance telecommunication operators and railroads)
- When available, any digital imagery that is used to identify facility locations in relation to the surrounding environment<sup>35/</sup>

## Project Owner

### 6–17: Accuracy of Location Information



**Practice Statement:** The project owner provides accurate information.

**Practice Description:** The project owner provides the excavator with accurate location information about the proposed excavation area using mapping information used by the one call center. This information includes a street address, street intersection, legal description, or other appropriately formatted information, such as orthophotography; and latitude/longitude (if feasible).<sup>26/</sup>

---

## 6-18: Excavation Area Details



**Practice Statement:** The project owner determines the excavation area's basic coordinates.

**Practice Description:** The project owner determines details about the excavation area location, such as starting and ending points, the side of the property (north, south, east, west, front, back, rear, sides, etc.), and side of the street.

Reference:

- These are general practices of the state departments of transportation regarding highway projects.
- These are general practices of most National Utility Contractors Association (NUCA) members. The references listed in each best practice are not all inclusive.

## Emerging Technologies

Technology is rapidly changing. Many of the best practices identified in this chapter could be obsolete in the near future. Although the following technologies are now used in other applications, their use is not widespread in the damage prevention field:

- Geographic Information System (GIS)
- Global Positioning System (GPS)
- Orthographic and satellite imagery

GIS allows the integration of digital maps with other databases to view the relationship of physical features; conducts relational queries; and obtains additional information on a particular feature. The GIS infrastructure or base will support all of the advanced technologies of GPS, orthographic, and satellite imagery.

Combining orthographic and satellite imagery with an overlay of a line map, street names, addresses, and GPS coordinates of utility lines will allow one call centers, excavators, locators, facility owners/operators, and project owners to view the accurate and relative location of utility lines.

Advanced use of these technologies in combination with advances to locating technologies is expected to reduce damage to underground facilities.



LEFT BLANK INTENTIONALLY

## CHAPTER 7

# Compliance

 One Call Center    Facility Owner    Excavator    Locator    Project Owner    Designer

### 7-1: Public and Enforcement Education



#### A: Public Education

**Practice Statement:** Public education programs are used to promote compliance.

**Practice Description:** A single entity is charged to promote comprehensive and appropriate programs to educate all stakeholders about the existence and content of the damage prevention laws and regulations. This is not meant to discourage individual stakeholders from providing educational programs.

#### Reference:

- New York: “Each one call notification system shall perform the following duties:... (b) Conduct a continuing program to: (1) Inform excavators of the one call notification system’s existence and purpose and their responsibility to notify the one call notification system of proposed excavation and demolition and to protect underground facilities. (2) Inform operators of the responsibility to participate in the one call notification system, to respond to a notice relating to a proposed excavation and demolition, and to designate and mark facilities according to the provisions of this Part.” New York Code, 16 NYCRR Part 753, § 753-5.3(b)(1)-(2)

#### B: Enforcement Education

**Practice Statement:** Mandatory education is considered as an alternative or supplement to penalties for offenders of the damage prevention laws and regulations.

**Practice Description:** When a violation of the damage prevention laws or regulations has occurred, mandatory education is an effective alternative or supplement to civil penalties. Mandatory education as an enforcement tool promotes compliance with damage prevention laws and regulations.

#### References:

- Arizona: “When a notice of violation (NOV) is issued, the following may be followed: 1. First Time Offenders: A. May be given a warning letter and Item C below...C. Given the opportunity to attend Blue Stake Training Course provided by the Arizona Corporation Commission’s Pipeline Safety Section.” Arizona Corporation Commission policy, “Notice of Violation,” § 1(A) and (C)
- New Hampshire: “Any excavator or operator who does not comply with RSA 374:51-54 shall be required on first offense to go through either a Dig Safe training program or be subject to a civil penalty...” New Hampshire Code, RSA 374, § 374:55(VIII)

## 7-2: Incentives



**Practice Statement:** Damage prevention programs include incentives to promote compliance with laws and regulations.

**Practice Description:** Incentives can include, but are not limited to, ease of access to one call center, membership and participation considerations, representation on one call boards, reasonable enforcement of regulations, safety and liability protection, access to alternative dispute resolution (ADR), and public education.

**Incentive—Membership:** Membership facilitates communication between an excavator and facility owner/operator, which helps prevent damage to underground facilities.

### References:

- Arizona: “If the owner or operator fails to locate or incorrectly locates the underground facility, pursuant to this article, the owner or operator becomes liable for resulting damages, costs, and expenses to the injured party.” Arizona Code, Article 6.3, § 40-360.27(C)
- Minnesota: “Reimbursement is not required if the damage to the underground facility was caused by the sole negligence of the operator or the operator failed to comply with section 216.04, subdivision 3.” Minnesota Code, Chapter 216D.06, Subd. 2(b)
- Pennsylvania: Stakeholders who do not join the one call system in violation of state law are not permitted to recover damages for injury to their property: “If a facility owner fails to become a member of a One Call System in violation of this act and a line or lines of such nonmember facility owner are damaged by a contractor by reason of the contractor’s failure to notify the facility owner because the facility was not a member of a One Call System serving the location where the damage occurred, such facility owner shall have no right of recovery from the contractor of any costs associated with the damage to its lines. The right herein granted shall not be in limitation of any other rights of the contractor.” Pennsylvania Code, 73 P.S. § 176 et. seq., Section 2(9)

**Incentive—Membership Accommodations:** To avoid cost being a barrier to membership, several states have made membership accommodations for smaller municipals and authorities.

### References:

- Arizona: “Each one call notification center shall establish a limited basis participation membership option, which may be made available to all members, but which must be made available for any member serving less than one thousand customers or any member irrigation or electrical district. A facility owner who elects limited basis participation membership will provide to the one call center the location of its underground facilities by identifying the incorporated cities and towns, or for unincorporated county areas, by identifying the townships, in which it has facilities. The service level provided to the limited basis participation members by the one call notification center is limited to providing excavators with names and telephone numbers the excavator should contact to obtain facilities location. Each one call center shall establish fair and reasonable fees for limited basis participation members, based on customer count, areas occupied or miles of underground facilities.” Arizona Code, Article 6.3, § 40-360.32. Note, Arizona’s system somewhat defeats the purpose of “one call,” but is successful because the Arizona Blue Stake (the one call center) goes the extra mile to assist the excavator in contacting the small facility owners, many of which do not have a manned telephone line.
- Minnesota: The Gopher State One Call Center instituted a no-locate-required policy, which credits the facility operator those charges for “not-involved” tickets. It results in cost savings to the facility owners/operators because one call center membership rates are based on the number of tickets received by the facility owners/operators.

- New York: “3. Costs. The costs of operating the system shall be apportioned equitably among the members of the system, with the exception of municipalities and authorities that operate underground facilities and any operator of underground facilities that provides water service to less than four thousand customers. In apportioning such costs, the system shall take into account the number of customers, extent of underground facilities, and frequency of use.” New York General Business Law Article 36, § 761
- Pennsylvania: “Operation costs for the One Call System shall be shared, in an equitable manner for services received, by facility owner members as determined by a One Call System’s board of directors. Political subdivisions with a population of less than two thousand persons or municipal authorities having an aggregate population in the area served by the municipal authority of less than five thousand persons shall be exempt from payment of any service fee.” Pennsylvania Code, 73 P.S. § 176 et. seq., Section 2(8)

**Incentive—One Call Center Board of Directors:** Boards are composed of representatives of all stakeholders. Representation of all stake holders in the governance of the one call center (although not necessarily in the administration of the one call center) ensures that the viewpoint of all stakeholders will be considered in the policies and programs of the one call center.

**References:**

- Minnesota: “The nonprofit corporation must be governed by a board of directors of up to 20 members, one of whom is the director of the office of pipeline safety. The other board members must represent and be elected by operators, excavators, and other persons eligible to participate in the center...” Minnesota Code, Chapter 216D.03, Subd. 2(a)
- Pennsylvania: “A one call system shall be governed by a board of directors, to be chosen by the facility owners. No less than twenty percent of the seats shall be held by municipalities or municipal authorities. The board shall include the following: (1) The Chairman of the Pennsylvania Public Utility Commission or his designee. (2) The Director of the Pennsylvania Emergency Management Agency or his designee. (3) The Secretary of Labor and Industry or his designee. (4) The Secretary of Transportation or his designee. (5) A contractor or industry representative. (6) A designer or industry representative.” Pennsylvania Code, 73 P.S. § 176 et. seq., Section 7.1(b)

**Incentive—Safety and Liability Protection:** Compliance with one call center requirements promotes worker safety and public safety and reduces exposure to liability.

**References:**

- New York: “The penalties provided for by this article shall not apply to an excavator who damages an underground facility due to the failure of the operator to comply with any of the provisions of this article nor shall in such instance the excavator be liable for repairs as prescribed in subdivision four of this section.” New York Code, 16 NYCRR Part 753, § 765(b).
- Pennsylvania: “The designer who has complied with the terms of this act and who was not otherwise negligent shall not be subject to liability or incur any obligation to facility owners, operators, owners, or other persons who sustain injury to person or property as a result of the excavation or demolition planning work of the designer.” Pennsylvania Code, 73 P.S. § 176 et. seq., Section 3(7).

**Incentive—Reasonable Enforcement of Regulations:** Reasonable enforcement of regulations refers to actions by enforcement authority officials and enforcement processes, both of which aim to fairly arrive at rational outcomes, such as education and penalties that correspond to the gravity of the violation, without imposing unnecessarily high transaction costs on any participant, including the enforcement authority.

**Reference:**

- In Massachusetts, a state where a violator’s “history” is considered when addressing a violation, repeat offenders of the one call law can attain first-time offender status if they demonstrate compliance for a solid year. “Any person, contractor, excavator, or company found by the Department to have violated any provision of the Dig Safe law or regulation adopted by the Department thereunder shall be subject to a civil penalty not to exceed \$500 for the first offense and not less than \$1,000 nor more than \$5,000 for any subsequent offense within a 12 month period after the Department issues a remedial order or executes a consent order for the first offense. Any excavator whose subsequent violation occurs after 12 consecutive months of no violations shall be subject to a civil penalty of \$500.” Massachusetts Regulation, 220 C.M.R. § 99.12(1)

### 7–3: Penalties



**Practice Statement:** Compliance programs include penalties for violations of the damage prevention laws or regulations.

**Practice Description:** Within the context of one call statutes, there exists specific provisions for penalties for failure to comply with the damage prevention laws and regulations. Performance and penalty incentives are equitably administered among stakeholders subject to one call provisions.

A **penalty system** includes education as an alternative or supplement to civil or other penalties.

**Reference:**

- New Hampshire: “Any excavator or operator who does not comply with RSA 374:51-54 shall be required on first offense to go through either a ‘Dig Safe’ training program or be subject to a civil penalty...” New Hampshire Code, RSA 374, § 374:55(VIII)

A **penalty system** also uses a tiered structure to distinguish violations by the level of severity or repeat offenses (e.g., warning letters, mandatory education, civil penalty amounts).

**References:**

- Arizona: “When a notice of violation (NOV) is issued, the following may be followed: 1. First Time Offenders: A. May be given a warning and Item C below or B. May be fined \$250 per violation and C. Given the opportunity to attend a Blue Stake Training Course provided by the Arizona Corporation Commission’s Pipeline Safety Section. Note: the investigator may use the NOV as a warning, if they feel a warning would suffice. 2. Second Offense: A. May be fined \$250 per violation and B. Given the opportunity to attend a Blue Stake Training Course provided by the Arizona Corporation Commission Pipeline Safety Section. 3. Repeat Offenders: A. Third Time: May be fined \$500 per violation. B. Four or More Times: Could be fined up to \$2000 per violation. Flagrancy or magnitude of offense could cause pipeline safety to deviate from this policy. Any deviation to the above-stated policy will jointly be determined by the Chief of Pipeline Safety and the Investigator.” Arizona Corporation Commission policy, “Notice of Violation,” section 1-3
- New York: “Warning letters: Upon determining that a probable violation(s) of a provision of Part 753 has occurred or is continuing, the Department may issue a warning letter notifying the Respondent of the probable violation and advising him or her to correct it, if it is correctable, and to comply henceforth, or be subject to enforcement actions under this Part.” NY Public Service Commission policy (proposed code § 753-6.3)

A **penalty system** also establishes mitigating and aggravating factors for determining the penalty for a violation by statute or regulation.

**References:**

- Massachusetts: “In determining the amount of the civil penalty, the Department shall consider the nature, circumstances, and gravity of the violation; the degree of the respondent’s culpability; the respondent’s history of prior offenses; and the respondent’s level of cooperation with the requirements of this regulation.” Massachusetts Regulation, 220 C.M.R. § 99.12(2)
- Minnesota: “In assessing a civil penalty under this part, the office shall consider the following factors: A. the nature, circumstances, and gravity of the violation; B. the degree of the person’s culpability; C. the person’s history of previous offenses; D. the person’s ability to pay; E. good faith on the part of the person in attempting to remedy the cause of the violation; F. the effect of the penalty on the person’s ability to continue business; and G. past reports of damage to an underground facility by a person.” Minnesota Rules, 7560.0800, Subpart 3
- New Hampshire: “In determining the assessment, the following factors shall be considered: (1) Severity of the consequences resulting from the violation: the more severe the consequences, the higher the civil penalty; (2) Mitigating circumstances: i.e., how quickly actions were taken to rectify the situation, how much control the company had over the situation, and other circumstance which would tend to less fault; and (3) Prior violations of Puc 800.” New Hampshire Regulation, Chapter Puc 800, § Puc 805.06(b)(1)-(3)
- New York: “...the commission shall determine the amount of the penalty after consideration of the nature, circumstances, and gravity of the violation, history of prior violations, effect on public health, safety or welfare, and such other matters as may be required and shall send a copy of its determination to the excavator, operator, commissioner of labor, and attorney general.” New York Public Service Law, § 119-b(8)
- Virginia: “In determining the amount of any civil penalty included in a settlement, the nature, circumstances, and gravity of the violation; the degree of the Respondent’s culpability; the Respondent’s history of prior offenses; and such other factors as may be appropriate shall be considered.” Virginia “Rules for Enforcement of the Underground Utility Damage Prevention Act,” § 6

A **penalty system** does not allow any violator or class of violators to be shielded from the consequences of a violation (i.e., all stakeholders should be accountable).

**Reference:**

- New Hampshire: “Any excavator or operator who does not comply with RSA 374:51-54 shall be required on first offense to go through either a ‘Dig Safe’ training program or be subject to a civil penalty...” New Hampshire Code, RSA 374, § 374:55(VIII)

## 7-4: Damage Recovery



**Practice Statement:** State damage prevention laws and regulations recognize the right to recover damages and costs resulting from noncompliance.

### A: Right of Recovery

**Practice Description:** The statute recognizes an injured party's right to recovery when damages and/or costs are incurred as the direct result of an entity's failure to comply with the one call laws and regulations. For example, Arizona endorses an injured party's right to recover damages when the other party has failed to comply with the one call law.

### References:

- Arizona: "If an underground facility is damaged by any person as a result of failing to obtain information as to its location, failing to take measures for protection of the facilities, or failing to excavate in a careful and prudent manner as required by this article, the person is liable to the owner of the underground facility for the total cost of the repair of the facility." Arizona Code, Article 6.3, § 40-360.26(A)
- Arizona: "If the owner or operator fails to locate or incorrectly locates the underground facility, pursuant to this article, the owner or operator becomes liable for resulting damages, costs, and expenses to the injured party." Arizona Code, Article 6.3, § 40-360.28(C)

### B: Alternative Dispute Resolution

**Practice Description:** Avenues for settlement of disputes include alternative dispute resolution. Minnesota endorses ADR through the state court system, New Jersey endorses ADR in construction contract documents, and the federal government endorses ADR through the federal courts.

### References:

- Minnesota: "The Supreme Court shall establish a statewide alternative dispute resolution program for the resolution of civil cases filed with the courts. The Supreme Court shall adopt rules governing practice, procedure, and jurisdiction for alternative dispute resolution programs established under this section. Except for matters involving family law, the rules shall require the use of nonbinding alternative dispute resolution processes in all civil cases, except for good cause shown by the presiding judge, and must provide an equitable means for the payment of fees and expenses for the use of alternative dispute resolution processes." Minnesota Code, Chapter Title: District Courts, § 484.76
- New Jersey: "All construction contract documents entered into in accordance with the provisions of P.L. 1971, c. 198 (C.40A:11-1 et seq.) after the effective date of P.L. 1997, c.371 (C.40A:11-50) shall provide that disputes arising under the contract shall be submitted to a process of resolution pursuant to alternative dispute resolution practices, such as mediation, binding arbitration, or non-binding arbitration pursuant to industry standards, prior to being submitted to a court for adjudication. Nothing in this section shall prevent the contracting unit from seeking injunctive or declaratory relief in court at any time. The alternative dispute resolution practices required by this section shall not apply to disputes concerning the bid solicitation or award process, or to the formation of contracts or subcontracts to be entered into pursuant to P.L. 1971, c. 198 (C.40A:11-1 et seq.)." New Jersey Code, Title 40A, § 40A-11-50

- Federal: “Congress finds that (1) alternative dispute resolution, when supported by the bench and bar, and utilizing properly trained neutrals in a program adequately administered by the court, has the potential to provide a variety of benefits, including greater satisfaction of the parties, innovative methods of resolving disputes, and greater efficiency in achieving settlements; (2) certain forms of alternative dispute resolution, including mediation, early neutral evaluation, minitrials, and voluntary arbitration, may have potential to reduce the large backlog of cases now pending in some federal courts throughout the United States, thereby allowing the courts to process their remaining cases more efficiently; and (3) the continued growth of Federal appellate court-annexed mediation programs suggests that this form of alternative dispute resolution can be equally effective in resolving disputes in the federal trial courts; therefore, the district courts should consider including mediation in their local alternative dispute resolution programs...Each United States district court shall authorize, by local rule adopted under section 2071(b) 2071(a), the use of alternative dispute resolution processes in all civil actions, including adversary proceedings in bankruptcy, in accordance with this chapter, except that the use of arbitration may be authorized only as provided in section 654 [(1) the action is based on an alleged violation of a right secured by the Constitution of the United States; (2) jurisdiction is based in whole or in part on section 1343 of this title; or (3) the relief sought consists of money damages in an amount greater than \$150,000.]” Alternative Dispute Resolution Act of 1998, enacted October 1998.

## 7-5: Enforcement



### A: Authority

**Practice Statement:** An authority is specified through state statutes and given the resources to enforce the law.

**Practice Description:** The enforcement authority in each state has the resources to enforce the laws and regulations. Experience has demonstrated that enforcement of the one call laws and regulations that did not identify a specific authority other than the attorney general has not been effective.

Characteristics of such an authority include the following:

- A process for receiving reports of violations from any stakeholder
- An operating budget source other than fine revenue, such as a line item in the state budget, excluding fines as a source of income for the authority
- Stakeholder involvement in periodic review and modification of enforcement processes
- Resources to respond to notifications of alleged violations in a timely manner
- A method of investigating alleged violations prior to issuing a notice of probable violation
- Impartial authority adjudicating violations
- An initial informal means of contesting a notice of violation
- A published violation review process and violation assessment considerations

### References:

- Arizona: The Pipeline Safety Division of the Arizona Corporation Commission is funded by the Commission budget. “Any penalties received by the state shall be deposited in the general fund.” Arizona Code, Article 6.3, § 40-360.28
- Massachusetts: “... Any other person may report a suspected violation of M.G.L. c. 82 s. 40 to the Department. All such reports shall be in a form deemed appropriate and necessary by the Department.” Massachusetts Regulation, 220 C.M.R. §99.01(1)



- Massachusetts: The Massachusetts Department of Telecommunications and Energy investigates all complaints received from excavators and facility owners/operators and conducts random field investigations. The Department then issues a Notice of Probable Violation if, based on the investigation, it has reason to believe that a violation has occurred or is occurring. “The Department may begin a proceeding by issuing a notice of probable violation (“NOPV”) if the Department has reason to believe that a violation of the M.G.L. c. 82, § 40, has occurred or is occurring...The NOPV shall state the factual basis for the allegation of a violation...” Massachusetts Regulation, 220 C.M.R. § 99.07(1)
- Minnesota: “The office shall issue a notice of probable violation when the office has good cause to believe a violation of Minnesota Statutes, sections 216D.01 to 216.D.09 of this chapter has occurred...A notice of violation must include: A. a statement of the statute or rule allegedly violated by the person and a description of the evidence on which the allegation is based.” Minnesota Rules, 7560.04000, Subp.1 - Subp. 2(A)
- Minnesota: See also Minnesota Rules, 7560.0400, Subp. 1, Notice of Violation; 7560.0500 Response Options; 7560.0600, Director Review; 7560.0800 Civil Penalties; Subp. 3, Assessment considerations
- New Hampshire: “Upon receipt of the NOPV [Notice of Probable Violation] the respondent shall either: (1) Submit in writing, within 30 days, evidence refuting the probable violation referenced in the NOPV; or (2) Request in writing within 30 days, an informal conference with commission staff to examine the basis of the violation, at which time the respondent may be represented by an attorney or other person; or (3) Waive procedural schedule by signing a consent agreement.” New Hampshire Regulation, Chapter Puc 800, § Puc 805.02
- New Hampshire: See also New Hampshire regulations, Chapter Puc 800, sections Puc 805.01, “Notice of Probable Violation”; Puc 805.02, Alternative Responses to Notice of Probable Violation; Puc 805.03, Notice of Violation; Puc 805.04, Response to Notice of Violation; Puc 805.05 Commission Action; Puc 805.06, Civil Penalties.
- Virginia: The Advisory Committee, which is established by statute to include “representatives of the following entities: Commission staff, utility operator, notification center, excavator, municipality, Virginia Department of Transportation, Board of Contractors, and underground line locator,” meets one day annually (in addition the monthly hearings) for “issue day,” a day to discuss issues and make recommendations to the State Corporation Commission (SCC) administrative three-judge panel on issues related to damage prevention. Subteams of the Advisory Committee are also formed to develop recommendations. “The purpose of the Committee is to...make recommendations with regard to Public Education and Awareness Programs that further public safety by the reduction of damage to the underground utility facilities in the Commonwealth and to monitor, analyze, influence, propose, support, or oppose programs or regulations that directly affect damage to underground facilities serving the citizens of the Commonwealth.” Bylaws of the Advisory Committee, Article II
- Virginia: “Upon receipt of a report of a probable violation, the Commission staff (“Staff”) shall conduct an investigation to examine all the relevant facts regarding the reported probable violation. The investigation may include, among other things, records verification, informal meetings, teleconferences, and photo-documentation. Upon completion of the investigation, the Staff shall review its findings and recommendations with the Advisory Committee established in accordance with 56-265.31 of the Act.” Virginia “Rules for Enforcement of the Underground Damage Prevention Act,” § 3

**B: Structured Review Process**

**Practices Statement:** A structured review process is used to impartially adjudicate alleged violations.

**Practice Description:** Two types of review processes currently used are outlined below. These type of processes differ in terms of 1) who receives reports of alleged violations, 2) who investigates the reports, 3) possible outcomes of the investigation, 4) who conducts first tier (informal) hearings, 5) possible outcomes of first tier hearings, and 6) appeal rights following a second tier (formal) hearing. It is important that review processes are constructed to avoid abuses of authority and prevent any individual, industry, stakeholder, or agency from exercising undue power or influence over the process.

**Type 1: Traditional Enforcement Authority**—This system is currently used in Arizona, Connecticut, Massachusetts, Minnesota, New Hampshire, New Jersey, New York, and Pennsylvania. Reports of alleged violations are sent to the State Agency. A state investigator investigates the reports. If the investigator decides not to issue a NOPV (Notice of Probable Violation), the matter is concluded. If not, the NOPV is issued, and the investigator conducts an informal hearing or review. If the investigator determines that no violation was committed, the matter is concluded. If the investigator determines that a violation was committed, the NOV (Notice of Violation) is issued. If the alleged violator does not contest the NOV, the alleged violation is bound by the facts, findings, orders, and penalties set forth in the NOV. If the alleged violator so requests, the State Agency conducts a formal hearing. The alleged violator may appeal the decision reached in the formal hearing to the state court system.

**Type 2: Advisory Committee (made up of stakeholders) partnered with State Agency**—This system is currently used in Virginia. Reports of alleged violations are sent to the State Enforcement Agency. The State Agency investigates the alleged violations and reports to an advisory committee. The Committee is made up of stakeholders representing the following statutorily mandated fields: excavators, facility owners/operators, notification centers, contract locators, local governments, State Department of Transportation, the Board of Contractors, and the State Enforcement Agency. If the advisory committee decides not to issue a NOPV (Notice of Probable Violation), the matter is concluded, possibly with a “letter of concern” containing one call information. If the advisory committee decides to issue an NOPV, it is issued by the State Agency. If the alleged violator does not request a hearing, the alleged violator is bound by the enforcement action set forth in the NOPV. If the alleged violator so requests, an informal hearing is held by the advisory committee. If the advisory committee decides that no violation was committed, the matter is concluded, subject to the right of the State Agency to contest that decision in an administrative proceeding conducted by the agency. If not, the NOV is issued. If the alleged violator then settles the matter with the advisory committee, the settlement is subject to approval by the State Agency in an administrative proceeding. If there is no settlement, the State Agency conducts a formal administrative hearing. The alleged violator may appeal the decision reached in the formal hearing to the state court system.

LEFT BLANK INTENTIONALLY

## CHAPTER 8

# Public Education and Awareness

 One Call Center    Facility Owner    Excavator    Locator    Project Owner    Designer

### 8-1: Marketing Plan



**Practice Statement:** An effective damage prevention education program includes a comprehensive, strategic marketing/advertising plan.

**Practice Description:** A comprehensive, strategic marketing/advertising plan enables better implementation, control, and continuity of advertising/public relations programs and ensures the most effective and efficient use of limited resources. These plans focus on setting realistic goals and allocating sufficient resources required to achieve those goals within a specified time frame. The marketing plan is a set of action steps based on a comprehensive situation analysis that clearly states the following:

- What is to be achieved
- How it will be achieved
- When it will be achieved
- Who is responsible for achieving each goal
- What amount of resources (time, people, and money) will be allocated to achieving each goal

#### References:

- Louisiana One Call Systems, Inc. Project 2000, 1998 Marketing Plan
- Public Awareness Marketing Plan for Underground Utility Damage Prevention, prepared for the Damage Prevention Quality Action Team by The Daily Planit, November 20, 1997
- Underground Protection Center (UPC) of Georgia
- Various one call centers including: AL, AZ, CT, GA, IL, IA, KY, MO, NM, NY (City), NC, OK, OH, OR, WV, and WI

### 8-2: Marketing 811—A National One Call Number<sup>32/</sup>



**Practice Statement:** An effective damage prevention education program includes promoting the National One Call Number (811) and awareness campaign by communicating the number and “call before you dig” process to excavators and the general public.

**Practice Description:** Practice Statement 8-1 identifies the need for a marketing plan and specifies that the plan include the promotion of the 811 number.

Stakeholder and marketing groups include the following:

- One call notification centers
- Owners and operators of underground facilities
- Construction industry
- Regulatory agencies

Product and services representatives from the one call industry actions that lead to a successful incorporation of 811 into your marketing plan include the following:

- Inclusion of the 811 logo on Web sites and newsletters
- Placing the 811 logo on owner/operator vehicles and equipment
- TV and radio promotions and public service announcements
- Billboard advertising
- Inclusion of the 811 logo on products and in service promotions

**References:**

- State one call centers
- Krylon Industries
- Colonial Pipeline

**8–3: Target Audiences and Needs<sup>32/</sup>**



**Practice Statement:** An effective damage prevention education program includes identification of target audiences and their individual needs.

**Practice Description:** Identification of target audiences ensures maximum impact for the Dig Safely message. The following target audiences are identified as examples:

- Professional designers
- Surveyors
- Construction management officials
- Excavation equipment operators
- Excavation equipment rental stores
- Excavators
- Public works excavators
- Locators
- Railroads
- Participating facility owners/operators
- Non-participating facility owners/operators (i.e., not one call members)
- Agricultural industry members
- Public officials
- Planning, zoning, licensing, permitting, and code enforcement officials
- Public utility board members
- Homeowners and associations
- Schools
- Landscape companies
- Geotechnical and environments soil testing laboratories
- Insurance industry members
- Marine operators
- Children
- Property owners/tenants
- Emergency responders/local emergency planning committee members
- News media

When target audiences are identified, their specific needs can be more readily addressed. This helps identify which media (e.g., free advertising, advertising, brochures, meal meetings, handouts, door hangers, yard cards, etc.) can most effectively be used to deliver the message. This also facilitates customization of the message itself. Coordination with other strategic partners can assist in reaching the greatest number of people.

**References:**

- Various one call centers including AL, AZ, CO, CT, GA, FL, ID, IL, IA, KY, MS, MO, NM, NY (City), NC, OK, OH, OR, TX, WV, and WI
- NUCA and various NUCA state chapters
- API, INGAA, and AGA member companies
- Associated General Contractors (AGC) chapters
- Door hangers from TCS Communications, LLC, of Florida
- Yard cards from Ohio Utilities Protection Service

8-4: Structured Education Programs<sup>65/</sup>

**Practice Statement:** An effective damage prevention education program is structured to accommodate the needs of stakeholder audiences.

**Practice Description:** Organizations that implement damage prevention programs need flexibility in selecting communication tactics based on demographics, damage events, effectiveness measurements, and other relevant factors. A wide range of methods and tools, including mailings, in-person meetings, events, mass media communications, educational videos, and electronic and social media, may be considered for damage prevention messaging. Examples for target audiences are provided below:

- **CONTRACTORS, ROAD BUILDERS, and EXCAVATORS**—Local and national trade shows and state/local chapters of contractor trade associations may provide opportunities for outreach. Group meetings focused on damage prevention education conducted by vendors and one call centers, as well as local utility coordinating committee (UCC) meetings, may also be valuable options for sharing damage prevention information. Consider education materials that are portable and suitable for a mobile workforce.
- **FARMERS and RANCHERS**—Messages for this audience should focus on damage prevention during agricultural-related activities, such as fencing and tiling. Local agriculture extension offices and state/local chapters of agriculture trade associations may be helpful in promoting education and messaging. Local farm days and county/state fairs can provide opportunities for broader outreach.
- **SCHOOL ADMINISTRATORS**—Contacting 811 prior to any digging on school property is an important message for administrators. Arbor Day and Earth Day are natural opportunities to promote safe digging messages at schools. Boards of education and local parent/teacher organizations (PTOs) may also provide support and resources.
- **SCHOOL STUDENTS**—Schools provide an opportunity to “grow” damage prevention awareness among younger audiences and their families. School education programs, offering a damage prevention curriculum and guest speakers, provide structured learning. Local scouting troops and student clubs focused on safety, environment, and civics may also provide opportunities for damage prevention education.
- **LOCATORS**—Locator training programs sponsored by one call centers, utility operators, or third-parties provide opportunities for damage prevention education. Locator trade associations and locator safety meetings may also be leveraged to provide outreach. Consider education materials that are portable and suitable for a mobile workforce.
- **PUBLIC OFFICIALS**—Public officials can influence local damage prevention procedures in their communities. Focus messaging on suggestions for including 811 in local permitting requirements to keep communities safer. Tours of one call centers and local utility facilities can also improve awareness among this audience.
- **EMERGENCY RESPONDERS**—Outreach to emergency responders can leverage existing public awareness programs, such as meetings with local emergency planning committees (LEPCs), local associations of fire chiefs and sheriffs, and organized group meetings. Focus messages on 811 requirements and recognizing the signs of an un-ticketed excavation, such as a lack of flags, paint, or utility personnel at dig sites, to raise responder awareness of damage prevention in their communities.
- **GENERAL PUBLIC AND HOMEOWNERS**—Homeowner/neighborhood association meetings provide opportunities for sharing the damage prevention message. Also consider attending and/or exhibiting at local home and garden shows. Social media messaging may also provide options for communication of damage prevention messages to this audience.

- MEDIA—Promoting damage prevention through the media helps to broaden awareness. Events such as 811 Day, National Safe Digging month, and local planned events can be communicated through press releases, print, TV, and radio interviews. As appropriate, media tours of operator facilities may also be useful.
- EQUIPMENT SUPPLIERS, DISTRIBUTORS, and RENTAL COMPANIES—Equipment points of sale or points of rental provide opportunities to educate potential excavators about 811 and damage prevention. It may be helpful to provide these companies with damage prevention brochures, 811 stickers for equipment, etc., to provide “just in time” reminders about the importance of calling 811 before digging.

**References:**

- Various one call centers including AL, AZ, CO, CT, GA, ID, IL, IA, KY, MS, MO, NM, NY (City), NC, OK, OH, OR, TX, WV, and WI
- Current industry materials, programs, and practices
- National Land Improvement Contractors Association
- American Petroleum Institute (API), Interstate Natural Gas Association of America (INGAA), and American Gas Association (AGA) member companies
- Industry associations including AGC chapters, NUCA, and National Telecommunications Damage Prevention Council (NTDPC)
- Various contract locating firms
- American Petroleum Institute (API) Recommended Practice (RP) 1162, “Public Awareness Programs for Pipeline Operators”

**8–5: Target Mailings**



**Practice Statement:** An effective damage prevention education program communicates vital damage prevention, safety, and emergency response information to target audiences through periodic mailings.

**Practice Description:** Target mailings can effectively communicate essential damage prevention, safety, and emergency response information. Direct mailings containing local information can be mailed to residents and businesses that lie within a specified area. Such mailings are especially useful for reaching those residents and businesses that are in the corridor of the underground facility or proposed excavation route. Some examples are listed below:

- Direct-mailed billing statements are ideal for including inserts provided by the one call center because the connection between underground facilities and Dig Safely can be readily made by the consumers.
- Additionally, space for a damage prevention message can be dedicated on the facility owners/operators’ newsletters that are often included with the billing statements.
- Direct mailings, either in the form of letters or newsletters, are effective in targeting audiences such as lumber yards and stores, hardware stores, heavy equipment sellers, and rental equipment stores. These mailings can offer support materials such as point-of-purchase brochure displays for sales counters, posters for retail aisles where digging equipment is found, and key chains for rental equipment ignition keys.
- An annual excavator newsletter, originated and mailed directly by the one call center to all identifiable excavators in the call center’s jurisdiction, keeps the customer base involved and informed of changes to the damage prevention system.
- Specialized brochures or letters can be mailed directly to address such issues as failure to follow local damage prevention laws, guidance to homeowners to understand the damage prevention process, and special requirements when excavations occur in agricultural or rural settings.

- Target mailing lists are developed using a combination of facility owners/operators' and one call center internal sources, support partner mailing lists, and ZIP-code + 4/SIC code mailing lists. There are numerous software applications and databases available in the marketplace to support this.

**References:**

- Various one call centers including AL, AZ, CT, GA, ID, IL, IA, KY, MS, MO, NM, NY (City), NC, OK, OH, OR, WV, and WI
- API Recommended Practice 1123
- 49 CFR Parts 192, 194, and 195

## 8-6: Paid Advertising



**Practice Statement:** An effective damage prevention education program includes paid advertising to increase damage prevention awareness and practices.

**Practice Description:** Paid advertising through event sponsorships, radio, television, and print media is an effective means for communicating one call center information and safe-digging requirements to target audiences. Paid advertising is particularly effective for reaching general excavators, construction designers and managers, equipment operators, property owners and tenants, farmers, facility owners/operators, and the general public. However, the use of paid advertising can be very costly, and a measurement for success should be implemented early in the advertising campaign to gauge effectiveness. Measurements can include increased locate ticket volume or increased number of first-time callers to a one call center. Additionally, creative placement of the message can ease the expense of paid advertising and enhance its effectiveness. Examples include transit system signs, sponsorship of news and weather reports on radio and television, industry trade exhibits and events, and print messages in trade publications.

**References:**

- Various one call centers including AL, CO, CT, GA, ID, IL, IA, KY, MS, MO, NM, NY (City), NC, OK, OH, OR, WV, and WI
- Current facility owner practices, including various oil pipeline companies such as Marathon-Ashland Pipeline Company, Northwest Pipeline Company, and Equilon Pipeline Company

## 8-7: Free Media<sup>33/</sup>



**Practice Statement:** An effective damage prevention education program utilizes all available free media.

**Practice Description:** When identified and used correctly, free media can be highly effective to communicate the Dig Safely message at minimal cost. For organizations with limited budgets, use of free media should be emphasized.

**Press Releases:** This tool is the preferred method to communicate “newsworthy” information about your damage prevention program to newspapers, trade publications, and radio stations. Examples of occasions/events that are appropriate for press releases include the following:

- Call center milestones (millionth call, record month, record day)
- Year in review (call volume statistics, damage reduction/increases)
- Election of new board members
- Announcement of excavator safety program schedule
- Announcement of a new utility member
- Changes to the state/local damage prevention law
- Seasonal “call before you dig” reminders



A basic press release, containing the damage prevention message and fundamental program information, is on file for distribution to newspapers and other periodicals that often run special sections on topics such as home improvements, safety around the home, and damage prevention actions related to severe weather. See Appendix C for a sample press release.

**Not-for-Profit Public Service Announcements (PSAs):** Television and radio stations, as well as billboard companies, often are willing to donate air time or space for public service announcements (PSAs) to not-for-profit organizations. To qualify, the organizations must have a safety-related message that benefits the general public.

**Member Facility Owners/Operators:** The member facility owners/operators of the damage prevention system are, in effect, another source of free media for the Dig Safely message:

- Major facility owners/operators who purchase paid advertising on television, radio, and billboards can require that free Dig Safely PSAs be included in any media buy they make.
- Cable TV members should be provided copies of any Dig Safely commercial and encouraged to run it as a PSA on their system. (Many cable members have created their own messages for this purpose!)
- All members facility owners/operators should be offered vehicle bumper stickers and posters to place on their locating and service vehicles promoting the “Call Before You Dig” phone numbers.

**State/Local Government:** State and local governments can be yet another source of free media for your damage prevention education program. The following are successful examples of their use:

- Use of proclamations by state and local governments to support “National Safe Digging Month.” See Appendix C for a sample press release
- Inclusion of safe-digging messages on state tollway/highway electronic message boards
- Damage prevention messages in community newsletters of member municipal facility operators

**References:**

- Various one call centers including AL, AZ, CO, CT, GA, ID, IL, IA, KY, MS, MO, NM, NY (City), NC, OK, OH, OR, TX, WV, and WI
- Various one call center member companies, such as Media-One, GTE, TCI Cable Co., Ameritech, and others
- Proclamations from various state and local governments
- Press release from Ohio Utilities Protection Service announcing Ohio’s Safe Digging Month (see Appendix C)

**8–8: Giveaways**



**Practice Statement:** An effective damage prevention education program uses promotional giveaway items to increase damage prevention awareness.

**Practice Description:** Effective damage prevention education programs use giveaways to reach targeted audiences. Examples include note pads, pens, Rolodex® cards, mouse pads, ignition protectors, clipboards, and magnets. Items used should reflect the unique needs and interests of the target audiences and the regions served. For example, sports towels work in many areas and with many audiences. However, beach towels are probably only effective in states or areas near beaches. Giveaways can be distributed via awareness and safety meetings, targeted mailings, sponsored events, trade shows, and other methods. In all cases, items should be usable both for work and recreation.

**Reference:**

- Various one call centers including AL, AZ, CO, CT, GA, ID, IL, IA, KY, MS, MO, NM, NY (City), NC, OK, OH, OR, TX, WV, and WI

## 8–9: Establishing Strategic Relationships



**Practice Statement:** An effective damage prevention education program establishes strategic relationships.

**Practice Description:** Strategic relationships can be defined as “Making Friends Before You Need Them.” This means having working relationships in place to leverage common resources. Successful damage prevention education programs establish strategic relationships with governmental agencies, emergency responders, associations of all types, media outlets, grass roots organizations, and others. These relationships involve partnering to further damage prevention education efforts. One example of such strategic relationships includes partnering with the state bureau of utilities, one call centers, OCSI members, the Equipment Manufacturers Institute (EMI) and original equipment manufacturers to install “North American Equipment Decals” on the dashboards of new excavating equipment. Another example is the One Call Systems Study (OCSS) for which this report is written. The OCSS represents the establishment of a strategic relationship among various one call systems stakeholders to further damage prevention education and awareness.

### References:

- Various one call centers including AL, AZ, CO, CT, GA, ID, IL, IA, KY, MS, MO, NY (City), NC, OK, OH, OR, TX, WV, and WI
- Illinois Commerce Commission
- Existing strategic relationships, such as APWA/AGC and API/NTDPC

## 8–10: Measuring Public Education Success



**Practice Statement:** An effective damage prevention education program includes structured annual or biennial (every two years) measurement(s) to gauge the success of the overall program.

**Practice Description:** Damage prevention education program effectiveness can be gauged in several ways. Consider the following examples:

- Use of a direct-mail or telephone survey to effectively determine how one call center and/or member facility customers are hearing and recalling the damage prevention message.
- Use of Arbitron Areas of Dominant Influence (ADI) boundaries to measure increases in one call center call volume and/or member facility owners/operators’ one call messages is also an effective measurement. For a given area, these can be compared against the money and resources used in that area for further indications of program effectiveness.
- The collection and tracking of individual or collective facility owners/operators’ damage information from year to year is another outstanding method of measuring success, providing that other internal factors at a given facility owner/operator remain constant.

### References:

- Various one call centers including CT, GA, IL, IA, KY, MS, MO, NC, OK, OH, and WI
- API Data Collection Initiative
- INGAA Foundation Pipeline Safety Awareness Material Focus Group Research Report
- “Presentation of Findings: OPS/DAMQAT Underground Facility Damage Prevention Study” (nationwide survey)
- “Presentation of Findings: DAMQAT Pilot Evaluation Study” (regional survey)
- Great Lakes Common Carrier Committee Six-State Survey
- Virginia State Corporation Commission survey on why damages occur
- PHMSA 9 Elements (PIPES ACT)

8–11: Cross Bore Determination and Mitigation<sup>69/</sup>



**Practice Statement:** A facility owner/operator has in place a robust, proactive mitigation program to identify and mitigate cross bores where its facilities may intrude upon another owner/operator’s facility. The facility owner/operator program promotes safe mitigation of cross bores. A facility owner/operator provides a communications network as a conduit for third parties to report potential cross bores.

**Practice Description:** A facility owner/operator implements a program to identify and mitigate instances where its facility may intrude upon another facility owner/operator’s facility.

When a foreign object such as a conduit, cable, or pipe is suspected to be within a nonpressurized underground facility or when the operation of that facility is impaired, a report of a “potential cross bore” is placed to a centralized point of contact (communications network). The communications network may be a service sponsored by the underground facility owner/operator or the One Call Center. The communications network notifies or provides the facility owner/operator’s contact information for the reported location. These reports are treated as an “emergency” under the overriding state law.

After identifying potential cross bore(s), the facility owner/operator takes appropriate action using the latest technologies to inspect the facilities. Utilizing technologies such as camera inspection both pre- and post-construction is effective in preventing new cross bores and mitigating legacy cross bores.

**References:**

This practice is currently in place in multiple states/locations including Pennsylvania, Minnesota, Virginia, Wisconsin, and Washington, D.C., as well as through the regular ticket process in other states. The practice is performed in several different ways to convey a potential cross-bore report to the involved party and to prevent injury to the drain-cleaning professional and/or the property owner.

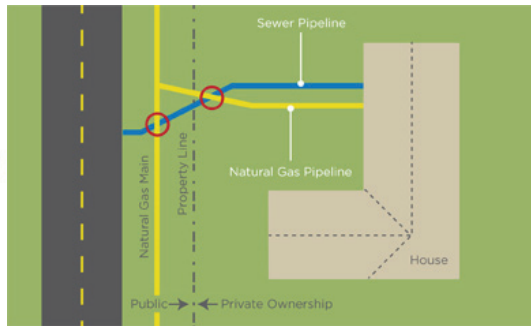
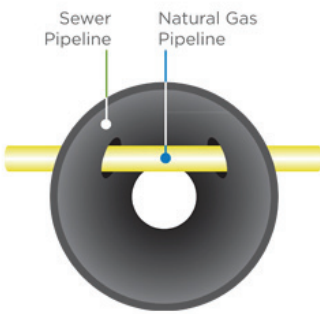

## CHAPTER 9

# Reporting and Evaluation

 One Call Center    Facility Owner    Excavator    Locator    Project Owner    Designer

### Best Practices Associated with Reporting Damage, Near Miss, and Incident Data<sup>58/</sup>

The following best practices related to reporting damage prevention data were reviewed by the CGA's Data Reporting & Evaluation Committee (DR&EC). Under each particular best practice is a partial list of examples identified during the creation of that best practice. Understanding this is a partial list, it should be recognized that other options may be available.

From a national data perspective, CGA Stakeholders recognize the CGA DIRT tool as the most beneficial source currently available for nationwide data regarding damages, near misses, and incident data.

#### 9-1: All Stakeholders Report Information



**Practice Statement:** Facility owners/operators, locators, excavators, or stakeholders with an interest in underground damage prevention report qualified information on events<sup>45/</sup> that could have, or did, lead to a damaged underground facility.

#### References:

- API/Association of Oil Pipelines (AOPL) Voluntary Accident Tracking Initiative
- Connecticut Department of Public Utility Control/Call Before You Dig, Inc.
- Consolidated Edison Company of New York, Inc.
- Florida Sunshine State One Call
- Massachusetts Department of Telecommunications and Energy
- New Hampshire Public Utilities Commission
- Pennsafe Bureau, Department of Labor and Industry
- Tennessee One Call System, Inc.
- Tierdael Construction Company—General Contractors
- U.S. Department of Transportation, Office of Pipeline Safety
- Virginia State Corporation Commission

### 9–2: Standardized Information Is Reported by All Stakeholders<sup>58/</sup>



**Practice Statement:** The requested data is standardized and consists of essential information that can be analyzed to determine what events could, or did, lead to a damaged facility. This means that collected data includes damage information, downtime, and near misses. All stakeholders submit the same damage, near miss, and downtime data via simple answers and check boxes. (Refer to Appendix C for example form)

**References:**

- API/AOPL Voluntary Accident Tracking Initiative
- Connecticut Department of Public Utility Control/Call Before You Dig, Inc.
- Consolidated Edison Company of New York, Inc.
- Florida Sunshine State One Call
- Massachusetts Department of Telecommunications and Energy
- New Hampshire Public Utilities Commission
- Pennsafe Bureau, Department of Labor and Industry
- Tennessee One Call System, Inc.
- Tierdael Construction Company—General Contractors
- U.S. Department of Transportation, Office of Pipeline Safety
- Virginia State Corporation Commission

### 9–3: Identify the Noncompliant Stakeholder



**Practice Statement:** It is important to identify the noncompliant stakeholder (facility owner/operator, excavator, locator, or one call notification center) so that this group can be targeted with education and training. It may not be necessary to pinpoint the names and addresses of the offenders for the purpose of improving the damage prevention program.

**References:**

- API/AOPL Voluntary Accident Tracking Initiative
- Connecticut Department of Public Utility Control/Call Before You Dig, Inc.
- Consolidated Edison Company of New York, Inc.
- Florida Sunshine State One Call
- Massachusetts Department of Telecommunications and Energy
- New Hampshire Public Utilities Commission
- Pennsafe Bureau, Department of Labor and Industry
- Tennessee One Call System, Inc.
- Virginia State Corporation Commission

### 9–4: Person Reporting Provides Detailed Information



**Practice Statement:** If all of the requested data is not available, the person reporting the information provides the most complete information possible.

**Reference:**

- Consolidated Edison Company of New York, Inc.

**9–5: Requested Information May Change**

**Practice Statement:** Requested information changes as additional or different data is deemed necessary for the evaluation process. The report is revised, as needed, to adapt to the changes in the state's statutes, the evolution of industry technology, and the awareness of root causes.

**References:**

- Connecticut Department of Public Utility Control/Call Before You Dig, Inc.
- Massachusetts Department of Telecommunications and Energy
- Tennessee One Call System, Inc.
- Virginia State Corporation Commission

**9–6: A Standardized Form Is Adopted**

**Practice Statement:** A standardized form that includes the mandatory DIRT fields is adopted and distributed to all facility owners/operators, locators, excavators, and other appropriate stakeholders. (Refer to Appendix C for example form)<sup>58/</sup>

**References:**

- API/AOPL Voluntary Accident Tracking Initiative
- Connecticut Department of Public Utility Control/Call Before You Dig, Inc.
- Massachusetts Department of Telecommunications and Energy
- NC811 DIRT Lite Form
- PA PDD (PA Damage Database)
- New Hampshire Public Utilities Commission
- Tennessee One Call System, Inc.
- United States Department of Transportation, Office of Pipeline Safety
- Virginia State Corporation Commission

**9–7: The Form Is Simple**

**Practice Statement:** Data is reported using a simple, standardized form. By limiting the number of hand-written responses, the information is easy to complete. Check-boxes or other simple answering techniques help the person reporting the information and make the evaluation process easier. (Refer to Appendix C for a example form)<sup>58/</sup>

**References:**

- API/AOPL Voluntary Accident Tracking Initiative
- Connecticut Department of Public Utility Control/Call Before You Dig, Inc.
- Florida Sunshine State One Call
- Massachusetts Department of Telecommunications and Energy
- NC811 DIRT Lite Form
- PA PDD (PA Damage Database)
- New Hampshire Public Utilities Commission
- Tennessee One Call System, Inc.
- U.S. Department of Transportation, Office of Pipeline Safety
- Virginia State Corporation Commission

### 9–8: Training Is Provided



**Practice Statement:** Training and education on how and when to complete the form are made available.

**References:**

- Connecticut Department of Public Utility Control/Call Before You Dig, Inc.
- New Hampshire Public Utilities Commission
- Tennessee One Call System, Inc.

### 9–9: Flexibility on Completing and Returning Form Is Provided



**Practice Statement:** Flexible options are provided for both completing and returning the form. This may include providing self-addressed and Web page forms and enabling completed forms to be faxed or reported by telephone.

**References:**

- API/AOPL Voluntary Accident Tracking Initiative
- Florida Sunshine State One Call
- New Hampshire Public Utilities Commission
- Pennsafe Bureau, Department of Labor and Industry
- Tennessee One Call System, Inc.
- Virginia State Corporation Commission

### 9–10: Vacant<sup>57/</sup>

### 9–11: Stakeholders Complete the Same Form



**Practice Statement:** If possible, facility owners/operators, excavators, locators, and anyone else involved in the damage prevention process complete the same form.

**Reference:**

- Virginia State Corporation Commission

### 9–12: An Organization Is Identified to Receive the Information



**Practice Statement:** A centralized and independent organization is identified to receive and process completed forms. DIRT is currently recognized as the national repository for housing damage data. All stakeholders submit damage, near miss, and downtime data via simple answers and check boxes. (Refer to Appendix C for example Form)<sup>58/</sup>

**References:**

- API/AOPL Voluntary Accident Tracking Initiative
- Connecticut Department of Public Utility Control/Call Before You Dig, Inc.
- Florida Sunshine State One Call
- New Hampshire Public Utilities Commission
- Pennsafe Bureau, Department of Labor and Industry
- Tennessee One Call System, Inc.
- U.S. Department of Transportation, Office of Pipeline Safety
- Virginia State Corporation Commission

### 9-13: The Organization Is Able to Interface with All Stakeholders



**Practice Statement:** The organization collecting the information is able to interface with all groups to promote completion and return of completed forms.

**References:**

- API/AOPL Voluntary Accident Tracking Initiative
- Connecticut Department of Public Utility Control/Call Before You Dig, Inc.
- Consolidated Edison Company of New York, Inc.
- Massachusetts Department of Telecommunications and Energy
- New Hampshire Public Utilities Commission
- Tennessee One Call System, Inc.



## Best Practices Associated with Evaluating Damage Prevention Data

The following best practices are related to evaluating damage prevention data and are developed by the Reporting and Evaluation Task Team. Under each best practice is a list of resources that were used as examples during the Task Team's discussions and may not be inclusive of all stakeholders that utilize the best practice.

### 9–14: An Organization Evaluates the Data



**Practice Statement:** A centralized and independent organization, such as the Data Reporting and Evaluation Committee, is identified to evaluate the completed forms and publish the data.<sup>58/</sup>

**References:**

- API/AOPL Voluntary Accident Tracking Initiative
- Connecticut Department of Public Utility Control/Call Before You Dig, Inc.
- New Hampshire Public Utilities Commission
- Tennessee One Call System, Inc.

### 9–15: The Organization Has Representation from All Stakeholders



**Practice Statement:** An organization such as the Data Reporting and Evaluation Committee, with representation from all interested stakeholders, assists in the evaluation process.<sup>58/</sup>

**References:**

- New Hampshire Public Utilities Commission
- Tennessee One Call System, Inc.
- Virginia State Corporation Commission

### 9–16: Data Is Used to Improve Damage Prevention Efforts



**Practice Statement:** The reported data is used to assess and improve underground damage prevention efforts.

**References:**

- API/AOPL Voluntary Accident Tracking Initiative
- Connecticut Department of Public Utility Control/Call Before You Dig, Inc.
- Consolidated Edison Company of New York, Inc.
- Massachusetts Department of Telecommunications and Energy
- New Hampshire Public Utilities Commission
- Tennessee One Call System, Inc.
- Virginia State Corporation Commission

### 9–17: Data Is Used to Promote Underground Damage Awareness<sup>58/</sup>



**Practice Statement:** The reported data is not used to penalize or punish; rather, it is used to promote underground damage awareness through recommended training and education.

**References:**

- Connecticut Department of Public Utility Control/Call Before You Dig, Inc.
- Tennessee One Call System, Inc.

### 9–18: Data Is Summarized by Key Components



**Practice Statement:** The reported data is summarized by key components.

**References:**

- Connecticut Department of Public Utility Control/Call Before You Dig, Inc.
- Consolidated Edison Company of New York, Inc.
- New Hampshire Public Utilities Commission
- Tennessee One Call System, Inc.
- Virginia State Corporation Commission

### 9–19: Root Causes Are Identified



**Practice Statement:** Root causes of events are identified.<sup>58/</sup>

**References:**

- API/AOPL Voluntary Accident Tracking Initiative
- Connecticut Department of Public Utility Control/Call Before You Dig, Inc.
- Consolidated Edison Company of New York, Inc.
- New Hampshire Public Utilities Commission
- Massachusetts Department of Telecommunications and Energy
- Virginia State Corporation Commission

### 9–20: Results Are Quantified Against a Standardized Risk Factor



**Practice Statement:** Results are quantified against a standardized risk factor. The risk factor considers a stakeholder's exposure to potential damage. This risk factor may be based on factors such as the number of miles of line installed or the number of one call center notification tickets. For example, a risk factor may compare how many underground damages occurred in a certain time period versus the total number of notification tickets issued.

**References:**

- Connecticut Department of Public Utility Control/Call Before You Dig, Inc.
- Consolidated Edison Company of New York, Inc.
- National Transportation Safety Board Safety Study: Protecting Public Safety through Excavation Damage Prevention (NTSB/SS-97-01)

### 9–21: Performance Levels and Trends Are Assessed



**Practice Statement:** Performance levels and trends are assessed against those of other organizations.

**References:**

- API/AOPL Voluntary Accident Tracking Initiative
- Connecticut Department of Public Utility Control/Call Before You Dig, Inc.
- Consolidated Edison Company of New York, Inc.
- New Hampshire Public Utilities Commission
- Tennessee One Call System, Inc.

LEFT BLANK INTENTIONALLY

## CHAPTER 10

### Miscellaneous

 One Call Center    Facility Owner    Excavator    Locator    Project Owner    Designer

#### 10–1: Homeland Security



**Practice Description:** Many of the recommended practices contained within the CGA's Best Practices Manual require the sharing of critical infrastructure information. This sharing is an important aspect of ensuring that parties involved with the identification of, the excavation around, and the general protection of underground facilities have adequate information to protect underground infrastructures. However, in the interest of Homeland Security, all parties must ensure that such information is shared only with individuals who truly require this critical information.

To this end, parties who employ or contract with individuals who may have access to such information should ensure that those individuals or contractors have the appropriate credentials to prevent the information from being accessed by individuals or groups that may intend to damage, alter, or destroy the infrastructure in question.<sup>5/</sup>

#### References:

- Existing state laws including South Carolina and North Carolina

LEFT BLANK INTENTIONALLY

## Glossary of Terms and Definitions

For the purpose of the Common Ground Study, a common set of definitions are used. These definitions were arrived at through a consensus process similar to the methodology used to identify the best practices.

**Abandoned Line or Facility:** Any underground or submerged line or facility no longer in use.

**Alternative Dispute Resolution (ADR):** Any process or procedure other than litigation that is agreed to by the disputing parties as the means for resolving a dispute, and is binding or non-binding pursuant to the agreement by the disputing parties. ADR includes, but is not limited to, advisory boards, arbitration, mini-trials, mediation, partnering, and standing neutrals.

**As-built Drawing:** A detailed depiction of facilities as installed in the field.

**Attribute:** Characteristic that helps describe the data.

**Backfill:** To fill the void created by excavating.

**Business Day (or Working Day):** Any day of the week except Saturday and Sunday and state/provincial and federal legal holidays.

**Cathodic Protection:** The process of arresting corrosion on a buried or submerged structure by electrically reversing the natural chemical reaction. This includes, but is not limited to, installation of a sacrificial anode bed, use of a rectifier based system, or any combination of these or other similar systems. Wiring is installed between the buried or submerged structure and all anodes and rectifiers; wiring is also installed to test stations that are used to measure the effectiveness of the cathodic protection system.

**Compliance:** Adherence to the statute and its regulations.

**Cross Bore:** An intrusion of an existing underground utility or underground structure by a second utility resulting in direct contact between the transactions of the utilities that compromises the integrity of either the utility or underground structure.<sup>69/</sup>

**Damage:** Any impact or exposure that results in the need to repair an underground facility due to a weakening or the partial or complete destruction of the facility, including, but not limited to, the protective coating, lateral support, cathodic protection, or housing for the line, device, or facility.

**Damage Reporting:** The immediate reporting to a one call center and the facility owner/operator of any damage caused or discovered in the course of excavation or demolition work; to immediately alert the occupants of premises as to any emergency that such person may create or discover at or near such premises; to contact emergency responders, if necessary, as quickly as practical.

**Demolition Work:** The partial or complete destruction by any means of a structure served by, or adjacent, to an underground line or facility.

**Designer:** Any architect, engineer, or other person who prepares or issues a drawing or blueprint for a construction or other project that requires excavation or demolition work.

**Digital Imagery:** A computer-compatible version of land-related information including, for example, topography, physical features, road/street networks, and buried facility networks obtained from a variety of sources including, for example, aerial photographs, satellite photographs, road maps, survey plans, and buried facility records.<sup>31/</sup>

**Downtime:** Lost time reported by a stakeholder on the Damage Information Reporting Tool (DIRT) field form for an excavation project due to failure of one or more stakeholders to comply with applicable damage prevention regulations.<sup>51/</sup>

**Electronic Positive Response:** Communication by telephone, fax, e-mail or Internet from a facility owner/operator to an excavator providing the status of an owner/operator's statutorily required response to a notice of intent to excavate.<sup>42/</sup>

**Emergency:** A sudden or unforeseen occurrence involving a clear and imminent danger to life, health, or property; the interruption of essential utility services; or the blockage of transportation facilities that requires immediate action.

**Emergency Notice:** A communication to the one call center to alert the involved underground facility owners/operators of the need to excavate as a result of a sudden or unforeseen occurrence or national emergency involving a clear and imminent danger to life, health, environment, or property (including the interruption of essential utility services or the blockage of transportation facilities) that requires immediate excavation.

**Emergency Response:** A facility owner/operator's response to an emergency notice.

**Event:** The occurrence of facility damage, near miss, or downtime.

**Excavate or Excavation:** Any operation using non-mechanized or mechanized equipment, demolition, or explosives in the movement of earth, rock, or other material below existing grade.<sup>50/</sup>

**Excavator:** Any person proposing to or engaging in excavation or demolition work for himself or for another person.

**Facility:** An underground or submerged conductor, pipe, or structure used to provide electric or communications service (including, but not limited to, traffic control loops and similar underground or submerged devices); or an underground or submerged pipe used in carrying, providing, or gathering (typically between the wellhead and transmission line) gas, oil or oil product, sewage, storm drainage, water, or other liquid service (including, but not limited to, irrigation systems) and appurtenances thereto.<sup>56/</sup>

**Facility Owner/Operator:** Any person, utility, municipality, authority, political subdivision, or other person or entity who owns, operates, or controls the operation of an underground line/facility.

**Geographic Information System (GIS):** An organized collection of computer hardware, software, and geographic data used to capture, store, update, maintain, analyze, and display all forms of geographically referenced information.

**Geospatial Data:** Data that identifies the geographic location and characteristics of natural or constructed features and boundaries on the earth.

**Global Positioning System (GPS):** A system consisting of 25 satellites used to provide precise position, velocity, and time information to users anywhere on earth. Location information can be received using a GPS receiver. The GPS receiver helps determine locations on the earth's surface by collecting signals from three or more satellites through a process called triangulation. Simple and inexpensive hand-held receivers provide an accuracy of  $\pm 100$  meters of a true position. More sophisticated receivers that use additional technologies or that post-process the original GPS data can provide sub-meter accuracy.

**Grade:** The surface of the earth (i.e., ground level) upon which a structure is built or prepared.

**Grounding Systems:** A system of one or more ground conductors or ground rods providing a low-resistance path-to-earth ground potential through a mechanical connection to structures, conductors, and equipment.

**Joint Trench:** A trench containing two or more facilities that are buried together by design or agreement.<sup>52/</sup>

**Land Base:** Mapped data that depicts features of the surface of the earth and is tied to real-world geographic coordinates, such as latitude and longitude.

**Large/Complex Project:** A single project, or a series of repetitive, small, short-term projects that are related in scope, that impact facilities over a long period of time or a large area.<sup>30/</sup>

**Latitude (Lat):** Distance measured north or south of the equator.

**Line:** See “Geographic Information System (GIS)”

**Locate:** To indicate the existence of a line or facility by establishing a mark through the use of stakes, paint, flagging, whiskers, or some other customary manner that approximately determines the location of that line or facility.<sup>44/</sup>

**Locate Request:** A communication between an excavator and one call center personnel in which a request for locating underground facilities is processed.

**Locator:** A person whose job is to locate lines or facilities.<sup>47/</sup>

**Longitude (Long):** Distance measured east or west from a reference meridian (Greenwich).

**Marking Standards:** The methods by which a facility owner/operator indicates its line or facility in accordance with the APWA guidelines. (See Appendix B, “Uniform Color Code and Marking Guidelines.”)

**Member Database:** Structured collection of data defined for a particular use, user, system, or program; it may be sequential, network, hierarchical, relational, or semantic.

**Membership:** Persons who participate voluntarily in a one call center because they have an interest in the protection of lines or facilities or because they have a statutory responsibility to protect lines or facilities.

**Minor or Routine Maintenance of Transportation Facilities:** The adding of granular material to unpaved roads, road shoulders, airport runways, airport taxiways, and railroad roadbeds; removal and application of patches to the surface of paved roads, runways, and taxiways; cleaning and sealing road, airport, and canal lock facility cracks or joints; replacing railroad ties and related appliances excluding road crossings; adjusting ballast on top of railroad roadbed; cleaning of paved drainage inlets and paved ditches or pipes.

**Near Miss:** An event where damage (as defined on page 91) did not occur, but a clear potential for damage was identified.<sup>43/</sup>

**Notice:** The timely communication by the excavator/designer to the one call center that alerts the involved underground facility owners/operators of the intent to excavate.

**Notification Period:** The time beginning when notice is given and ending when the work may begin.

**One Call Center:** An entity that administers a system through which a person can notify owners/operators of lines or facilities of proposed excavations.

**Orthophoto:** An aerial photograph of a site that has been differentially rectified to correct the distortion caused by the terrain and attitude (tip, tilt, and yaw) of the camera. A multicolored, distortion-free, photographic image.

**Person:** Any individual or legal entity, public or private.

**Planning:** An activity at the beginning of a project where information is gathered and decisions are made regarding the route or location of a proposed excavation based on constraints, including the locations of existing facilities, anticipated conflicts and the relative costs of relocating existing facilities, or more expensive construction for the proposed facility.

**Plat:** A map or representation on paper of a piece of land subdivided into lots, with streets, alleys, etc., usually drawn to a scale.

**Positive Response:** Communication with the excavator prior to excavation to ensure that all contacted (typically via the one call centers) owner/operators have located their underground facilities and have appropriately marked any potential conflicts with the areas of planned excavation.

**Pre-marking or Positive Site Identification:** The marking of the proposed excavation site/work area consistent with APWA guidelines.



**Private Service Line:** A buried facility/line wholly owned and operated on private property by an entity or individual who is not in the business of providing a product or service via that buried facility/line.<sup>71/</sup>

**Project Owner:** The person financially responsible for the undertaking of a project that involves excavation or demolition.<sup>27/</sup>

**Public:** The general population or community at large.<sup>28/</sup>

**Railroad Operating Corridor:** The property that is essential to a railroad company to enable it to discharge its function and duties as a common carrier by rail. It includes the road bed, right of way, tracks, bridges, stations, and such like property.<sup>29/</sup>

**Root Cause:** The primary reason an event occurred.<sup>48/</sup>

**Subsurface Utility Engineering (SUE):** An engineering process for accurately identifying the quality of underground utility information needed for excavation plans and for acquiring and managing that level of information during the development of a project.

**Test Hole:** Exposure of a facility by safe excavation practices used to ascertain the precise horizontal and vertical position of underground lines or facilities.

**Ticket Number:** A unique identification number assigned by the one call center to each locate request.<sup>49/</sup>

**Tolerance Zone:** The space in which a line or facility is located and in which special care is to be taken.

**Vacuum Excavation:** A means of soil extraction through vacuum; water or air jet devices are commonly used for breaking the ground.<sup>38/</sup>

## APPENDIX B

# Uniform Color Code and Marking Guidelines

The information contained in this appendix is intended to supplement information for existing practices found within CGA Best Practices.<sup>8/</sup>

### BEST PRACTICES CHAPTER 4—LOCATING AND MARKING

*Practice Statement 4-3: Color Code: A uniform color code and set of marking symbols is adopted nationwide.*

## Uniform Color Code<sup>9/</sup>

The following APWA uniform color code (ANSI Z535.1) shall be adopted as the uniform color code for marking excavation sites and underground facilities in conflict with an excavation. This recommendation is not intended to preempt any existing state requirement that specifies other colors.

White	Proposed Excavation
Pink	Temporary Survey Markings
Red	Electric Power Lines, Cables, Conduit, and Lighting Cables
Yellow	Gas, Oil, Steam, Petroleum, or Gaseous Materials
Orange	Communication, Alarm or Signal Lines, Cables, or Conduit
Blue	Potable Water
Purple	Reclaimed Water, Irrigation, and Slurry Lines
Green	Sewers and Drain Lines

### References:

- APWA Uniform Color Code
- Existing operating practices from various states' one call centers
- Existing one call laws from various states
- ANSI Standard Z535.1 Safety Color Code

**BEST PRACTICES CHAPTER 5—EXCAVATION**

*Practice Statement 5-19: Excavation Tolerance Zone: The excavator observes a tolerance zone that is comprised of the width of the facility plus 18 in. on either side of the outside edge of the underground facility on a horizontal plane. This practice is not intended to preempt any existing state/provincial requirements that currently specify a tolerance zone of more than 18 in.*

**Tolerance Zone<sup>40/</sup>**

The following examples are of tolerance zones for a 1 in. and 12 in. line:

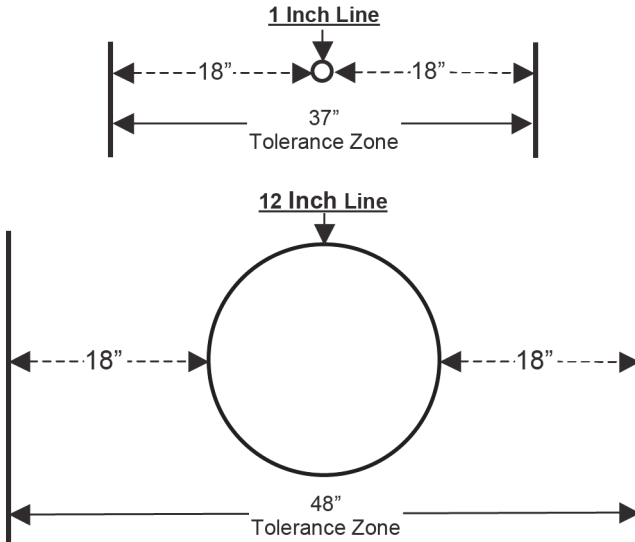

**BEST PRACTICES CHAPTER 5—EXCAVATION**

**Practice Statement 5-2: White Lining<sup>67/</sup>:** When the excavation site cannot be clearly and adequately identified on the locate ticket, the excavator designates the route and/or area to be excavated using white premarking, either onsite or electronically (when available through the one call center), prior to or during the request for the locate ticket.

**Guidelines for Excavation Delineation<sup>9/</sup>**

The following marking illustrations are examples of how excavators may choose to mark their area of proposed excavation. The use of white marking products (e.g., paint, flags, stakes, whiskers, or a combination of these) may be used to identify the excavation site.

**Single Point Excavations Markings**

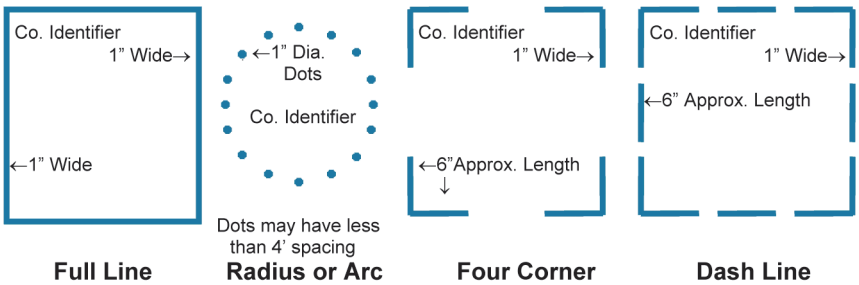

Delineate in white<sup>62/</sup> the proposed area of excavation using a continuous line, dots marking the radius or arcs, dashes marking the four corners of the project, or dashes outlining the excavation project. Limit the size of each dash to approximately 6 in. to 12 in. long and 1 in. wide with interval spacing approximately 4 ft to 50 ft apart. Reduce the separation of excavation marks to a length that can reasonably be seen by the operator's locators when the terrain at an excavation site warrants. Dots of approximately 1 in. diameter typically are used to define arcs or radii and may be placed at closer intervals in lieu of dashes.

**Single Stake Marking Center Point of Excavation Site**

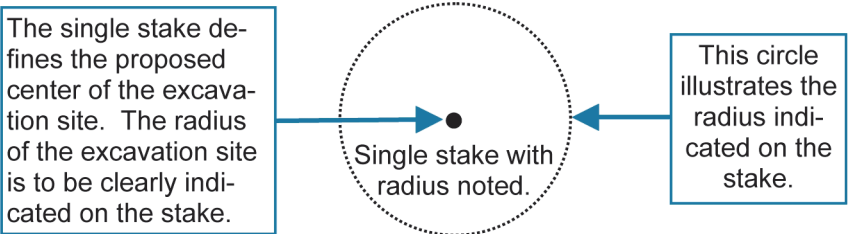

When an excavation site is contained within a 50 ft maximum radius or less, it can be delineated with a single stake that is positioned at the proposed center of the excavation. If the excavator chooses this type of delineation, they must convey that they have delineated the excavation site with a single stake at the center of the excavation and include the radius of the site in the notification to the one call center. This single stake is white in color and displays the excavator's company identifier (name, abbreviations, or initials) and the radius of the excavation site in black letters on the stake or with a notice attached to the stake.

**Trenching, Boring, or Other Continuous-Type Excavations**

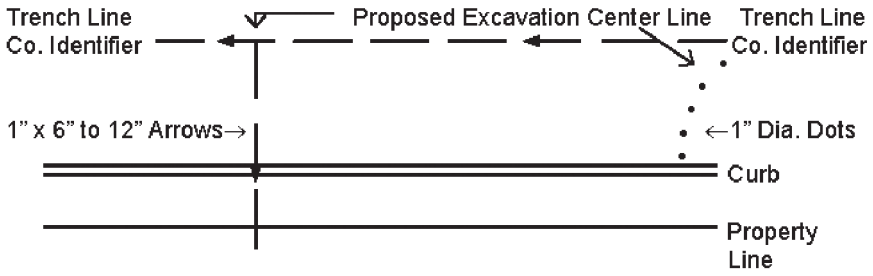

**Continuous Excavation Marking**

Mark in white<sup>62/</sup> the proposed centerline of planned excavation using 6 in. to 12 in. x 1 in. arrows approximately 4 ft to 50 ft apart to show direction of excavation. Reduce the separation of excavation marks to a length that can reasonably be seen by the operator’s locators when the terrain at an excavation site warrants. Mark lateral excavations with occasional arrows showing excavation direction from centerline with marks at curb or property line if crossed. Dots may be used for curves and closer interval marking.

**Stake, Flag, or Whisker Excavation Markers**



Delineate the proposed area of excavation using stakes, flags, or whiskers instead of spray paint to mark radius or arcs; the four corners of the project; or when outlining the excavation project. Limit the interval spacing to approximately 4 ft to 50 ft. Reduce the separation of excavation marks to a length that can reasonably be seen by the operator’s locators when the terrain at an excavation site warrants. Stakes, flags, or whiskers provided to illustrate arcs or radii may be placed at closer intervals to define the arc or radius. Stakes, flags, or whiskers are white in color and display the excavator’s company identifier (name, abbreviations, or initials).

**BEST PRACTICES CHAPTER 4—LOCATING AND MARKING**

*Practice Statement 4-3: Color Code: A uniform color code and set of marking symbols is adopted nationwide.*

**Guidelines for Operator Facility Field Delineation<sup>9/</sup>**

Operator markings of facilities include the following:

- The appropriate color for their facility type
- Their company identifier (name, initials, or abbreviation) when other companies are using the same color
- The total number of facilities and the width of each facility
- A description of the facility (HP, FO, STL, etc).

Use paint, flags, stakes, whiskers, or a combination to identify the operator's facility(s) at or near an excavation site.

1. Marks in the appropriate color are approximately 12 in. to 18 in. long and 1 in. wide, spaced approximately 4 ft to 50 ft apart. When marking facilities, the operator considers the type of facility being located, the terrain of the land, the type of excavation being done, and the method required to adequately mark the facilities for the excavator.

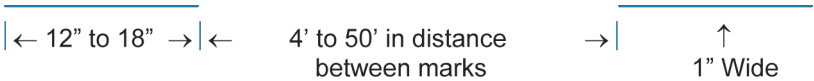

2. The following marking examples illustrate how an operator may choose to mark their subsurface installations:

- a. **Single Facility Marking:** Used to mark a single facility. This can be done in one of two ways—1) placing the marks over the approximate center of the facility:

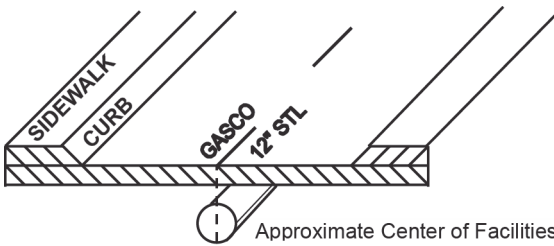

or 2) placing the marks over the approximate outside edges of the facility with a line connecting the two horizontal lines (in the form of an H) to indicate there is only one facility:

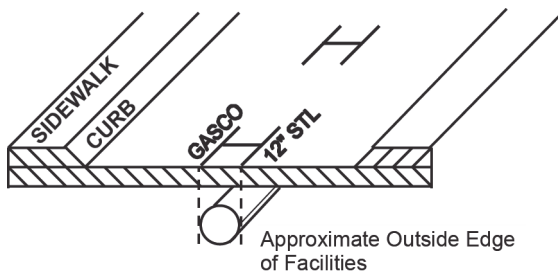

These examples indicate an operator's 12 in. facility. When a facility can be located or toned separately from other facilities of the same type, it is marked as a single facility.<sup>41/</sup>

- b. **Multiple Facility Marking:** Used to mark multiple facilities of the same type (e.g., electric), where the separation does not allow for a separate tone for each facility, but the number and width of the facilities is known. Marks are placed over the approximate center of the facilities and indicate the number and width of the facilities.

**Example:** four plastic facilities that are 4 in. in diameter (4/4" PLA)

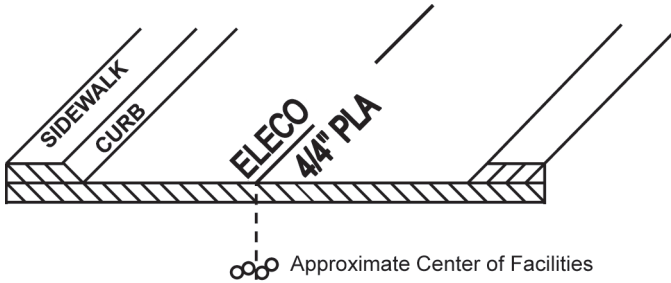

- c. **Conduit Marking:** Used for any locatable facility being carried inside conduits or ducts. The marks indicating the outer extremities denote the actual located edges of the facilities being represented.

**Example:** four plastic conduits that are 4 in. in diameter (4/4" PLA), and the marks are 16 in. apart, indicating the actual left and right edges of the facilities

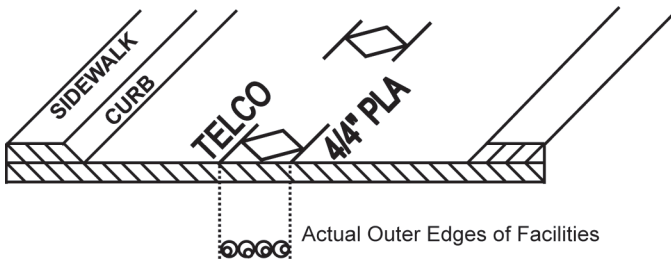

- d. **Corridor Marking:** Used to mark multiple facilities of the same type (e.g., electric), bundled or intertwined in the same trench, where the total number of facilities is not readily known (operator has no record on file for the number of facilities). Marks are placed over the approximate center of the facilities and indicate the width of the corridor. The width of the corridor is the distance between the actual located outside edges of the combined facilities.

**Example:** a 12 in. corridor (12" CDR)

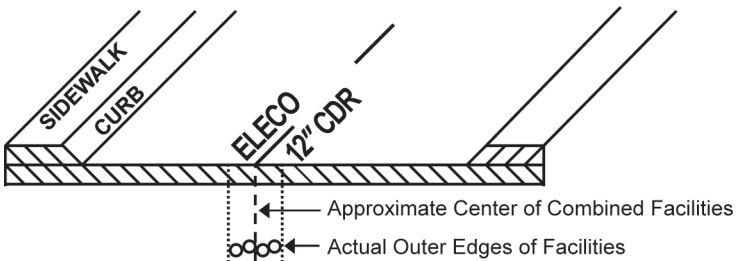

- Changes in direction and lateral connections are clearly indicated at the point where the change in direction or connection occurs, with an arrow indicating the path of the facility. A radius is indicated with marks describing the arc. When providing offset markings (paint or stakes), show the direction of the facility and distance to the facility from the markings.

**Example: radius**

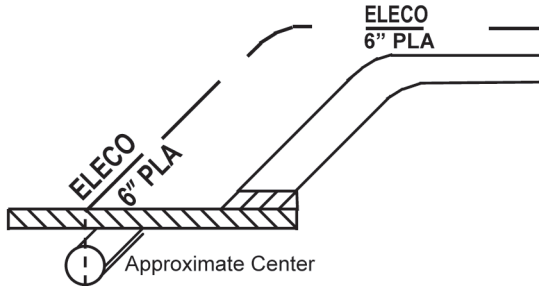

**Example: lateral connection**

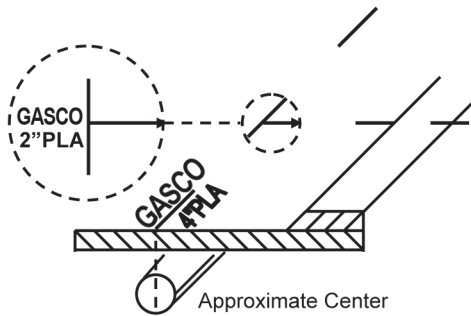

**Example: painted offset (off)**

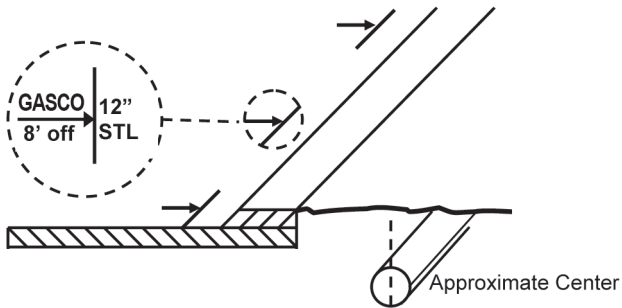

**Example: staked offset (off)**

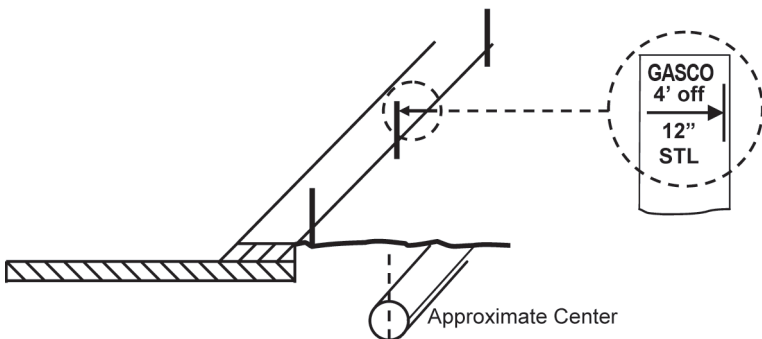



4. An operator's identifier (name, abbreviation, or initials) is placed at the beginning and at the end of the proposed work. In addition, subsequent operators using the same color mark their company identifier at all points where their facility crosses another operator's facility using the same color. Reduce the separation of excavation marks to a length that can reasonably be seen by the operator's locators when the terrain at an excavation site warrants.

**Examples:**

CITYCO

ELECO

TELCO

5. Information regarding the size and composition of the facility is marked at an appropriate frequency.

**Examples:** the number of ducts in a multi-duct structure, width of a pipeline, and whether it is steel, plastic, cable, etc.

TELCO  
9/4" CAB

GASCO  
4" PLA

WATERCO  
12" STL

6. Facilities installed in a casing are identified as such.

**Examples:** 6 in. plastic in 12 in. steel and fiber optic in 4 in. steel

GASCO  
6" PLA/12" STL

TELCO  
FO(4" STL)

7. Structures such as vaults, inlets, and lift stations that are physically larger than obvious surface indications are marked so as to define the parameters of the structure.

**Example:**

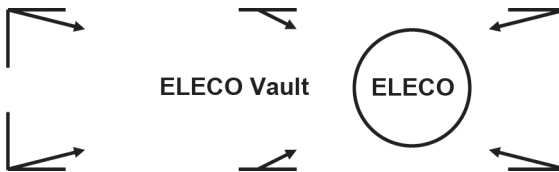

8. Termination points or dead ends are indicated as such.

**Example:**



9. When there is "No Conflict" with the excavation, complete one or more of the following:

- Operators of a single type of facility (e.g., TELCO) mark the area "NO" followed by the appropriate company identifier in the matching APWA color code for that facility.

**Example:** NO TELCO

- Operators of multiple facilities mark the area "NO" followed by the appropriate company identifier in the matching APWA color code for that facility with a slash and the abbreviation for the type of facility for which there is "No Conflict."

**Example:** NO GASCO/G/D illustrates that GASCO has no gas distribution facilities at this excavation site. The following abbreviations are used when appropriate: /G/D (gas distribution); /G/T (gas transmission); /E/D (electric distribution); /E/T (electric transmission).

- Place a clear plastic (translucent) flag that states “No Conflict” in lettering matching the APWA color code of the facility that is not in conflict. Include on the flag the operator’s identifier, phone number, a place to write the locate ticket number, and date. Operators of multiple facilities indicate on the flag which facilities are in “No Conflict” with the excavation (see the previous example).
- If it can be determined through maps or records that the proposed excavation is obviously not in conflict with their facility, the locator or operator of the facility may notify the excavator of “No Conflict” by phone, fax, or e-mail, or through the one call center, where electronic positive response is used. Operators of multiple facilities indicate a “No Conflict” for each facility (see the previous examples).
- Place “No Conflict” markings or flags in a location that can be observed by the excavator and/or notify the excavator by phone, fax, or e-mail that there is “No Conflict” with your facilities. When the excavation is delineated by the use of white markings, place “No Conflict” markings or flags in or as near as practicable to the delineated area.

Caution: Allow adequate space for all facility mark-outs.

“No Conflict” indicates that the operator verifying the “No Conflict” has no facilities within the scope of the delineation; or when there is no delineation, there are no facilities within the work area as described on the locate ticket.

**Example:**

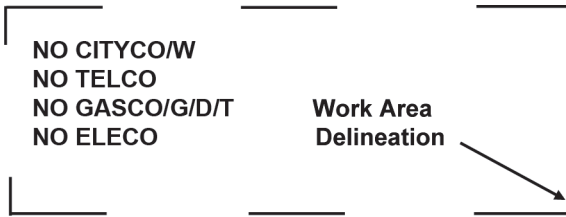

### **Color Code Identifiers**

White	Proposed Excavation
Pink	Temporary Survey Markings
Red	Electric Power Lines, Cables, Conduit, and Lighting Cables
Yellow	Gas, Oil, Steam, Petroleum, or Gaseous Materials
Orange	Communication, Alarm or Signal Lines, Cables, or Conduit
Blue	Potable Water
Purple	Reclaimed Water, Irrigation, and Slurry Lines
Green	Sewers and Drain Lines

## Common Abbreviations

### Facility Identifier

CH	Chemical
E	Electric
FO	Fiber Optic
G	Gas
LPG	Liquefied Petroleum Gas
PP	Petroleum Products
RR	Railroad Signal
S	Sewer
SD	Storm Drain
SS	Storm Sewer
SL	Street Lighting
STM	Steam
SP	Slurry System
TEL	Telephone
TS	Traffic Signal
TV	Television
W	Water
W	Reclaimed Water "Purple"

### Underground Construction Descriptions

C	Conduit
CDR	Corridor
D	Distribution Facility
DB	Direct Buried
DE	Dead End
JT	Joint Trench
HP	High Pressure
HH	Hand Hole
MH	Manhole
PB	Pull Box
R	Radius
STR	Structure (vaults, junction boxes, inlets, lift stations)
T	Transmission Facility

**Infrastructure Material**

ABS	Acrylonitrile - Butadiene - Styrene
ACP	Asbestos Cement Pipe
CI	Cast Iron
CMC	Cement Mortar Coated
CML	Cement Mortar Lined
CPP	Corrugated Plastic Pipe
CMP	Corrugated Metal Pipe
CU	Copper
CWD	Creosote Wood Duct
HDPE	High Density Polyethylene
MTD	Multiple Tile Duct
PLA	Plastic (conduit or pipe)
RCB	Reinforced Concrete Box
RCP	Reinforced Concrete Pipe
RF	Reinforced Fiberglass
SCCP	Steel Cylinder Concrete Pipe
STL	Steel
VCP	Verified Clay Pipe

**Guide for Abbreviation Use**

Follow these guidelines when placing abbreviations in the field:

- Place the Company Identifier at the top or at the left of the abbreviations.
- Place the abbreviations in the following order: Company Identifier / Facility Identifier / Underground Construction Descriptions / Infrastructure Material

**Example:** TELCO/TEL/FO/PLA indicates that TELCO has a telecommunication fiber optic line in a single plastic conduit. The use of the abbreviation /TEL is not necessary, because the orange marking would indicate that the facility was a communication line; but its use is optional.

- To omit one or more of the abbreviation types, use the order described above but omit the slash and abbreviation that does not apply.

**Example:** to omit /TEL), the result would be TELCO/FO/PLA.

LEFT BLANK INTENTIONALLY

## APPENDIX C

# Sample Forms, Reports, and Releases

During the Common Ground Study, the Reporting and Evaluation Task Team drafted a sample report form (originally referred to as figure 9-1) to demonstrate what may be reported when collecting damage prevention information. The team created this sample form (illustrated on the following page) using the best practices from one call center, regulatory agency, facility, locator, excavator, and industry group report forms. The form was created to enable data collection from all stakeholders involved in the damage prevention process, including facility owners/operators, excavators, and locators.

### Appendix C Sample Form

The 9-1 form was the basis for the development of the CGA's Damage Information Reporting Tool (DIRT) launched in December 2003. The Data Reporting & Evaluation Committee approved minor modifications to the original 9-1 form when creating DIRT. These modifications were later approved by the CGA Best Practices Committee. The approved DIRT form has been included in Appendix C. To review the electronic version and tool, visit <http://www.cga-dirt.com>.

### References:

The following references were used as examples during the Task Team's discussions and the development of the composite 9-1 reporting form. These sources do not include all stakeholders that may report any of the same information shown on the sample form.

- Connecticut Department of Public Utility Control/Call Before You Dig, Inc.
- Consolidated Edison Company of New York, Inc.
- Florida Sunshine State One Call
- Massachusetts Department of Telecommunications and Energy
- National Transportation Safety Board Safety Study: Protecting Public Safety Through Excavation Damage Prevention (NTSB/SS-97-01)
- New Hampshire Public Utilities Commission
- Tennessee One Call System, Inc.
- Tierdael Construction Company—General Contractors
- Virginia State Corporation Commission

**BEST PRACTICES CHAPTER 9—REPORTING AND EVALUATION**

**Practice Statement 9-6: A Standardized Form Is Adopted:** A standardized form that includes the mandatory DIRT fields is adopted and distributed to all facility owners/operators, locators, excavators, and other appropriate stakeholders. (Refer to Appendix C for example form)<sup>58/</sup>

**Sample Form: Damage Information Reporting Tool (DIRT)—Field Form**

FRESH DIRT (beginning 2018)

Rev: 11/7/2017

\*\* indicates a Required Field

**Damage Information Reporting Tool (DIRT) - Field Form**

**Part A – Original Source of Event Information**

Who is providing the information?  Excavator  Public Works  Telecommunications  Liquid Pipeline  Railroad  Electric  Locator  Road Builders  Unknown/Other  Engineer/Design  Natural Gas  Equipment Manufacturer  Private Water  Federal / State Regulator

Name of person providing the information:

**Part B – Type, Date, and Location of Event**

Type of Event:  DIRT Event  Underground Damage  Underground Near Miss  
 Non-DIRT Event  Above Grade  Aerial  Natural Cause  Submarine

\*Date of Event: (MM/DD/YYYY)  
 \*Country \*State \*County City  
 Street address: Nearest Intersection:  
 Latitude/Longitude: Lat: Lon  Decimal Degrees  D M S

\*Right-of-Way where event occurred  
 Public:  City Street  State Highway  County Road  Interstate Highway  Public-Other  
 Private:  Private Business  Private Land Owner  Private Easement  Pipeline  Power /Transmission Line  Dedicated Public Utility Easement  Federal Land  Railroad  Unknown/Other

**Part C – Affected Facility Information**

\*What type of facility operation was affected?  
 Natural Gas  Sewer  Steam  Cable Television  Electric  Liquid Pipeline  Telecommunications  Water  Unknown/Other

\*What type of facility was affected?  
 Distribution  Gathering  Service/Drop  Transmission  Unknown/Other

Was the facility part of a joint trench?  Yes  No  Unknown  
 Did this event involve a Cross Bore?  Yes  No  Unknown  
 Was facility owner One Call Center member?  Yes  No  Unknown  
 If No, is facility owner exempt from One Call Center membership?  Yes  No  Unknown

Measured Depth  Embedded in concrete/asphalt pavement  <18" / 46 cm  >36" / 91 cm Measured depth from grade \_\_\_\_\_ in/cm  
 From Grade  18" – 36" / 46 - 91 cm

**Part D – Excavation Information**

\*Type of Excavator  Contractor  Occupant  County  Railroad  Developer  State  Farmer  Municipality  Utility  Unknown/Other

\*Type of Excavation Equipment  Auger  Backhoe/Trackhoe  Boring  Bulldozer  Drilling  Directional Drilling  Explosives  Farm Equipment  Grader/Scraper  Hand Tools  Milling Equipment  Probing Device  Trencher  Vacuum Equipment  Unknown/Other

\*Type of Work Performed  Agriculture  Bldg. Construction  Bldg. Demolition  Cable Television  Curb/Sidewalk  Drainage  Driveway  Electric  Engineering/Survey  Fencing  Grading  Irrigation  Landscaping  Liquid Pipeline  Milling  Natural Gas  Pole  Public Transit Auth.  Railroad  Road Work  Sewer  Site Development  Steam  Storm Drain/Culvert  Street Light  Telecommunication  Traffic Signal  Traffic Sign  Water  Waterway Improvement  Unknown/Other

**Part E – Notification and Locating**

\*Was the One-Call Center notified?  Yes  No Ticket Number \_\_\_\_\_

If Yes, type of locator  Facility Owner  Contract Locator  Unknown/Other

If No, is excavation activity and/or excavator type exempt from notification?  Yes  No  Unknown

Was work area white-lined?  Yes  No  Unknown

**Part F – Intentionally left blank**

Sample Form for Reporting Data

FRESH DIRT (beginning 2018)

Rev: 11/7/2017  
 \*\* indicates a Required Field

**Part G – Excavator Downtime**

Did Excavator incur down time?  Yes  No

If yes, how much time?  < 1 hr  1 - <2 hrs  2 - <3 hrs  3+ hrs Exact Value \_\_\_\_\_  Unknown

Estimated cost of down time?  \$0  \$1 -1000  \$1,001 - 5,000  \$5,001 - 25,000  
 \$25,001 - 50,000  >\$50,000 Exact Value \_\_\_\_\_  Unknown

**Part H – Interruption and Restoration**

\*Did the damage cause an interruption in service?  Yes  No  Unknown

If yes, duration of interruption  < 1 hr  1 - <6 hrs  6 - <12 hrs  12 - <24 hrs  24 - <48 hrs  
 48+ hrs Exact Value \_\_\_\_\_ hrs  Unknown

Approximately how many customers were affected?  
 Unknown  0  1  2 - 10  11 - 50  51+ Exact Value \_\_\_\_\_

Estimated cost of damage / repair/restoration:  \$0  \$1 - 1,000  \$1,001 - 5,000  \$5,001 - 25,000  
 \$25,001 - 50,000  > \$50,000 Exact Value \_\_\_\_\_  Unknown

**\*Part I – Root Cause Select only one**

<p><b>Notification Issue</b></p> <p><input type="checkbox"/> No notification made to One Call Center/ 811</p> <p><input type="checkbox"/> Excavator dug outside area described on ticket</p> <p><input type="checkbox"/> Excavator dug prior to valid start date/time</p> <p><input type="checkbox"/> Excavator dug after valid ticket expired</p> <p><input type="checkbox"/> Excavator provided incorrect notification information</p> <p><b>Excavation Issue</b></p> <p><input type="checkbox"/> Excavator dug prior to verifying marks by test-hole (pothole)</p> <p><input type="checkbox"/> Excavator failed to maintain clearance after verifying marks</p> <p><input type="checkbox"/> Excavator failed to protect/shore support facilities</p> <p><input type="checkbox"/> Improper backfilling practices</p> <p><input type="checkbox"/> Marks faded or not maintained</p> <p><input type="checkbox"/> Improper excavation practice not listed above</p> <p><b>Miscellaneous Root Causes</b></p> <p><input type="checkbox"/> Deteriorated facility <input type="checkbox"/> One Call Center Error <input type="checkbox"/> Previous damage</p> <p><input type="checkbox"/> Root Cause not listed (comment required)</p>	<p><b>Locating Issue</b></p> <p><i>Facility not marked due to:</i></p> <p><input type="checkbox"/> Abandoned facility</p> <p><input type="checkbox"/> Incorrect facility records/maps</p> <p><input type="checkbox"/> Locator error</p> <p><input type="checkbox"/> No response from operator/contract locator</p> <p><input type="checkbox"/> Tracer wire issue</p> <p><input type="checkbox"/> Unlocatable Facility</p> <p><i>Facility marked inaccurately due to</i></p> <p><input type="checkbox"/> Abandoned facility</p> <p><input type="checkbox"/> Incorrect facility records/maps</p> <p><input type="checkbox"/> Locator error</p> <p><input type="checkbox"/> Tracer wire issue</p>
---	--

**Part J – Additional Comments**

---

**Part Z – Images and Attachments:** List the file names of any images and attachments to submit with this report

Visit [www.cga-dirt.com](http://www.cga-dirt.com)

Starting with 2018 data, all submissions should use the new field form outlined above. Please visit [www.cga-dirt.com](http://www.cga-dirt.com) for additional details and to access the updated field form.



**BEST PRACTICES CHAPTER 8—PUBLIC EDUCATION AND AWARENESS**

**Practice Statement 8-7: Free Media<sup>33/</sup>:** *An effective damage prevention education program utilizes all available free media.*

**Sample Press Release**

For Immediate Release

GOV. STRICKLAND PROCLAIMS APRIL AS SAFE DIGGING MONTH IN OHIO

Ohio Utilities Protection Service reminds local residents to call before all digging projects

Youngstown, Ohio (April 1, 2009) — Gov. Ted Strickland issued a proclamation announcing his support for National Safe Digging Month in April. The proclamation reminds Ohio do-it-yourself homeowners to call the Ohio Utilities Protection Service (O.U.P.S.) before starting any outdoor digging projects.

April marks the start of spring digging season, so O.U.P.S. and Gov. Strickland are encouraging homeowners to call O.U.P.S. before they dig to prevent injuries, property damage and inconvenient outages. Failure to call before digging results in Americans unintentionally hitting underground utility lines more than 200,000 times annually, which can lead to injury, penalties, repair costs, and inconvenient outages.

When calling 800-362-2764 or 8-1-1, homeowners are connected to O.U.P.S., which notifies the appropriate utility companies of the intent to dig. Professional locators are sent to the requested digging site to mark the approximate locations of underground lines with flags or spray paint. Once lines have been marked, digging can begin around marked lines.

“We strongly encourage individuals and companies to call O.U.P.S. before they begin digging,” said Abby Dornon, Public Relations and Communications Coordinator for the Youngstown-based center. “By marking underground lines, homeowners are eliminating the risk of striking a line, ultimately avoiding injury and inconvenient outages.”

Striking a single line can cause injury, repair costs, fines and inconvenient outages. Every digging project no matter how large or small necessitates a call to 800-362-2764 or 8-1-1. Installing a mailbox, putting in a fence, building a deck and laying a patio are all examples of digging projects that need a call to O.U.P.S. before starting.

Visit [www.oups.org](http://www.oups.org) for more information about the call-before-you-dig process.

About the Ohio Utilities Protection Service

The Ohio Utilities Protection Service (O.U.P.S.), located in Youngstown, Ohio, is a non-profit corporation established to serve as a notification center that takes information from persons engaging in excavation activities and distributes this information to its utility members.

The Ohio Utilities Protection Service's mission is to provide a quality one call process to protect the public, protect the underground infrastructure and protect the environment. Serving the entire state, O.U.P.S. processes more than one million calls annually.

It is the law in Ohio (sections 3781.25 to 3781.32 of the revised code) to contact a one call center before digging.

# Additional References and Endnotes

## Additional References

The references contained in Appendix D are intended to be supplemental references for existing and/or new practices found within the CGA Best Practices.

### Trenchless Excavation

Chapter 2: Practice Statement 2–13

Chapter 4: Practice Statement 4–19

Chapter 5: Practice Statement 5–29

### References

American Gas Association (AGA), "Directional Drilling Damage Prevention Guidelines for the Natural Gas Industry," Technical Note, December 30, 2004.

American Society of Civil Engineers, ASCE Manuals and Reports on Engineering Practice No. 89, "Pipeline Crossings," 1996.

Bennett, R.D., S.T. Ariaratnam, and C. Como, "Horizontal Directional Drilling Good Practices Guidelines," HDD Consortium, Washington, DC, ISBN 1-928984-13-4, 2001.

California Department of Transportation, CALTRANS, "CALTRANS Encroachment Permits—Guidelines and Specifications for HDD Installations," July 14, 2003.

Directional Crossing Contractors Association (DCCA), "Guidelines for Successful Directional Crossing Survey Standards," Dallas, TX, 1999.

Directional Crossing Contractors Association (DCCA), "Horizontal Drilling Safe Operations Guidelines," Dallas, TX, 1995.

Gas Research Institute, "Final Report—Guideline for the Application of Guided Horizontal Drilling to Install Gas Distribution Piping," GRI-96-0368, September 1996.

National Transportation Safety Board, "Safety Study: Protecting Public Safety Through Excavation Damage Prevention," Washington, DC, December 1999.

National Utility Contractors Association (NUCA), "Trenchless Construction Methods and Soil Compatibility Manual," 3rd Edition, Washington, DC.

National Utility Locating Contractors Association (NULCA), "Excavation Practices & Procedures for Damage Prevention," Spooner, WI, 1996.

## Endnotes

When endnotes begin with a date, this is the date that the amendment or addition was approved by CGA's Board of Directors.

1. National Transportation Safety Board, 1995. Proceedings of the Excavation Damage Prevention Workshop; 1994 September 8-9; Washington, DC, Report of Proceedings NTSB/RP-95/01 (pp.177-178), Washington, DC.
2. National Utility Locating Contractors Association, 2002. Locator Training Standards and Practices, Spooner, WI
3. 11/30/2001 Amendment approved by the CGA Board via TR-2001-02A
4. 09/27/2002 Amendment approved by the CGA Board via TR-2001-02B
5. 04/08/2003 Addition approved by the Best Practices Committee
6. 09/25/2003 Amendment approved by the CGA Board via TR-2001-04

7. 03/26/2004 Amendment approved by the CGA Board via TR-2003-02
8. 09/24/2004 Information contained in this appendix approved by the CGA Board
9. 09/24/2004 Amendment approved by the CGA Board via TR-2001-05
10. 03/04/2005 Amendment approved by the CGA Board via TR-2004-02
11. 03/04/2005 Amendment approved by the CGA Board via TR-2004-03
12. 04/15/2005 Amendment approved by the CGA Board via TR-2004-04A
13. 09/16/2005 Amendment approved by the CGA Board via TR-2002-03
14. 09/16/2005 Amendment approved by the CGA Board via TR-2004-04B
15. 09/08/2006 Amendment approved by CGA Board via TR-2002-04
16. 09/08/2006 Amendment approved by the CGA Board via TR-2005-02
17. 11/16/2006 Amendment approved by CGA Board via TR-2006-02
18. 08/24/2007 Modification to statement approved by the CGA Board via TR-2007-01
19. 08/24/2007 Modification to statement approved by the CGA Board via TR-2007-02
20. 08/24/2007 Modification to description approved by the CGA Board via TR-2007-03
21. 11/15/2007 Amendment approved by the CGA Board via TR-2007-04
22. 08/08/2008 Amendment approved by CGA Board via TR-2007-05
23. 08/08/2008 Amendment approved by the CGA Board via TR-2007-06
24. 11/14/2008 Amendment approved by the CGA Board via TR-2005-05
25. 12/12/2008 Amendment approved by the CGA Board via TR-2006-03
26. 05/15/2009 Amendment approved by the CGA Board via TR-2008-01
27. 10/16/2009 Addition approved by the CGA Board via TR-2009-01
28. 10/16/2009 Addition approved by the CGA Board via TR-2009-04
29. 10/16/2009 Addition approved by the CGA Board via TR-2009-05
30. 10/16/2009 Addition approved by the CGA Board via TR-2009-07
31. 10/16/2009 Amendment approved by the CGA Board via TR-2009-08
32. 12/04/2009 Addition approved by the CGA Board via TR-2009-17
33. 12/04/2009 Amendment approved by the CGA Board via TR-2009-20
34. 03/03/2010 Amendment approved by the CGA Board via TR-2008-02
35. 07/16/2010 Amendment approved by the CGA Board via TR-2008-03
36. 07/16/2010 Amendment approved by the CGA Board via TR-2009-16
37. 07/16/2010 Final wording approved by the CGA Board via TR-2009-16
38. 09/10/2010 Addition approved by the CGA Board via TR-2009-09
39. 09/10/2010 Amendment approved by the CGA Board via TR-2009-09
40. 09/10/2010 Amendment approved by the CGA Board via TR-2010-01A
41. 09/10/2010 Amendment approved by the CGA Board via TR-2010-01B
42. 06/17/2011 Addition approved by the CGA Board via TR-2009-12
43. 08/26/2011 Addition approved by the CGA Board via TR-2010-05
44. 12/01/2011 Amendment approved by the CGA Board via TR-2010-04
45. 08/10/2012 Amendment approved by CGA Board via TR-2010-02
46. 08/10/2012 Addition approved by CGA Board via TR-2011-02
47. 08/10/2012 Addition approved by the CGA Board via TR-2011-06
48. 08/10/2012 Addition approved by the CGA Board via TR-2011-07

49. 08/10/2012 Addition approved by the CGA Board via TR-2011-08
50. 08/10/2012 Amendment approved by the CGA Board via TR-2011-09
51. 12/13/2012 Addition approved by the CGA Board via TR-2011-03
52. 12/13/2012 Addition approved by the CGA Board via TR-2011-05
53. 12/13/2012 Addition approved by CGA Board via TR-2012-05
54. 10/24/2013 Addition approved by CGA Board via TR-2011-01
55. 12/05/2013 Amendment approved by the CGA Board via TR-2009-14
56. 12/05/2013 Amendment approved by the CGA Board via TR-2013-02
57. 06/19/2014 Practice removal approved by the CGA Board via TR-2010-02
58. 06/19/2014 Wording approved by CGA Board via TR-2010-02
59. 06/19/2014 Wording approved by CGA Board via TR-2011-11
60. 12/11/2014 Wording approved by CGA Board via TR-2012-01
61. 11/04/2015 Amendment approved by Best Practices Committee via TR-2013-03
62. 11/04/2015 Approved by Best Practices Committee via TR-2015-03
63. 07/22/2016 Approved by CGA Board via TR-2015-01
64. 12/13/2016 Approved by CGA Board via TR-2014-01
65. 12/13/2016 Approved by CGA Board via TR-2015-02
66. 12/13/2017 Approved by CGA Board via TR-2015-03
67. 12/13/2017 Approved by CGA Board via TR-2016-01
68. 07/27/2018 Approved by CGA Board via TR 2017-02
69. 03/26/2019 Approved by CGA Board via TR 2014-02
70. 07/24/2019 Approved by CGA Board via TR 2013-01
71. 01/16/2020 Approved by Best Practices Committee via TR-2018-01

LEFT BLANK INTENTIONALLY

## CGA MEMBER ORGANIZATIONS

3M

AEGIS Insurance Service, Inc.

AIMS Companies

Air Products and Chemicals, Inc.

Alabama811

Aligning Change

Alliance Pipeline

Alliant Energy

Ameren Illinois

American Gas Association

American Midstream LP

American Petroleum Institute

American Public Gas Association

American Public Works Association

Andeavor

Arizona 811

Arkansas One Call Systems, Inc.

Associated General Contractors of America

Association of American Railroads

Association of Australian Dial Before You Dig Services Ltd

Association of Equipment Manufacturers

Association of Oil Pipe Lines

AT&T

Atmos Energy Corporation

Avista Corporation

Badger Daylighting Corporation

Baltimore Gas and Electric Company

Barnard Pipeline

Berntsen International, Inc

Black & Veatch Corporation

Black Hills Energy

Blood Hound, Inc.

Blue Stakes of Utah 811

Blueknight Energy Partners, L.P.

BP America & BP Pipelines North America

Buckeye Partners, LP

C.S. McCrossan Construction, Inc.

CenterPoint Energy

Centurion Pipeline L.P.

Charge EPC  
Cheniere Pipeline  
Chesapeake Energy Corporation  
Chevron Corporation  
CHS Inc.  
Citizens Energy Group  
City of Chicago - DIGGER  
City of Duluth  
City of Lexington  
City of Long Beach Gas & Oil Department  
Clarke-Mobile Counties Gas District  
Colonial Pipeline  
Colorado 811  
Colorado Springs Utilities  
Consumers Energy  
Corinth Gas & Water  
CoServ  
Countrymark Refining & Logistics, LLC  
Cox Utility Services, Inc.  
CPN Pipeline Company  
Crimson Midstream, LLC  
Cyera Strategies  
Dakota Gasification Company  
Daphne Utilities  
Deere & Company  
Department of Homeland Security/CISA  
Dig Safe System, Inc  
Dig Safely New York Inc.  
Diggers Hotline, Inc.  
Distribution Contractors Association  
Ditch Witch  
Dominion Energy Ohio  
Dow Pipeline Company  
DTE Energy  
Electricom  
ELM Companies  
Enable Midstream Partners, LP  
Enbridge Energy Company, Inc.  
Energy Transfer  
Enertech  
EnLink Midstream

---

Enterprise Products  
Enview  
Equix  
Excavation Alert Systems, LLC  
Explorer Pipeline Company  
Flagshooter Inc  
Flint Hills Resources  
FS3 Inc.  
Gardner Telecommunications LLC  
Genesis Energy, L.P.  
Georgia 811 (Utilities Protection Center)  
Gold Shovel Standard  
Golden Pass Pipeline  
Gopher State One Call  
GPRS  
Grady Crawford Construction Co., Inc of Baton Rouge  
Greenville Utilities Commission  
Greer CPW  
GridHawk LLC  
GTI  
Henkels & McCoy Group  
Holly Energy Partners  
Info Excavation  
International Association of Fire Chiefs  
Interstate Energy Company  
Interstate Natural Gas Association of America  
Intren, Inc.  
Iowa One Call  
irth Solutions  
JULIE, Inc. (Illinois One-Call System)  
Kansas One Call  
Kentucky Public Service Commission  
Kern River Gas Transmission  
Kid Energy USA  
Kinder Morgan  
Knoxville Utilities Board  
KorTerra  
Krylon Products Group  
Lake Apopka Natural Gas District  
Lancaster Area Sewer Authority  
Leica Geosystem



LG&E Energy  
Lockton Companies, LLC  
LOOP, LLC  
Louisiana One Call  
LyondellBasell  
Magellan Midstream Partners, L.P.  
Marathon Pipe Line, LLC  
Maryland Underground Facilities Damage Prevention Authority  
MasTec North America, Inc.  
MDU Resources  
MetroNet  
Michels Corporation  
MidAmerican Energy  
Midwest Energy, Inc.  
Miller Pipeline, LLC  
MISS DIG System, Inc  
Miss Utility of Delmarva  
Mississippi 811, Inc.  
Missouri One Call  
National Association of Pipeline Safety Representatives  
National Fuel Gas  
National Grid  
National Telecommunications Damage Prevention Council  
Network Infrastructure, Inc.  
New Jersey Natural Gas  
New Mexico Gas Company  
New York 811, Inc.  
NiSource  
NORFIELD Development Partners  
North Carolina 811, Inc.  
Northern Natural Gas  
NUCA  
NULCA  
NuStar Energy LP  
NW Gas  
OHIO811  
Okaloosa Gas District  
Oklahoma One-Call System, Inc.  
One Call Concepts, Inc.  
One Call of Wyoming  
ONE Gas

---

ONEOK  
OpvanteK  
Orange & Rockland Utilities Inc  
Oryx Midstream Services  
Pacific Gas and Electric Company  
PacifiCorp  
Paradigm  
PECO Energy Company  
PelicanCorp One Call, Inc.  
Pennsylvania 811  
Peoples Gas  
Pepco Holdings, Inc.  
Phillips 66 Pipeline LLC  
Piedmont Natural Gas  
Pinnacle West Capital Corp/APS  
Pipeline & Hazardous Materials Safety Administration  
Plains All American Pipeline, L.P.  
Portland General Electric  
Power and Communication Contractors Association  
Premier Infrastructure & Energy  
Primoris  
Public Service Electric & Gas Company  
Puget Sound Energy  
Quanta Services  
Questar Gas Company  
Radiodetection  
Rockpoint Gas Storage  
Rust-Oleum Corporation  
SAMCO  
San Diego Gas & Electric  
Scott Commercial Contracting  
Sellenriek Construction  
SENSIT Technologies  
Shell Pipeline Company LP  
SiteWise, LLC  
South Carolina 811  
South Dakota 811  
South Jersey Gas Company  
Southeast Gas  
Southern California Gas Company  
Southern Company

Southern Star Central Gas Pipeline, Inc  
Southwest Gas Corporation  
SPEC Services, Inc.  
Spire  
Sunshine 811  
Tallgrass Energy  
Targa Resources, Inc.  
TC Energy  
TECO Peoples Gas  
Tennessee 811  
Texas 811  
TransMontaigne Operating Company L.P.  
Transwest  
TRUVAC by Vactor Manufacturing  
UGI Utilities, Inc .  
Underground Safety Alliance (USA)  
Unearth  
Union Sanitary District  
Urbint  
USA North 811  
USIC  
UtiliQuest  
UTTO  
Vac-Con, Inc  
VAC-TRON Equipment LLC  
Valero Energy Corp.  
Verizon  
Vermeer Corporation  
Virginia Utility Protection Service, Inc.  
Vivax - Metrotech Corporation  
Washington 811 (Utilities Underground Location Center)  
Washington Gas  
WEC Wisconsin Operations  
West Valley Construction  
Western Midstream Partners, LP  
Westfield Gas & Electric  
Whiting Oil & Gas Corporation  
Williams  
Wolverine Pipe Line Company  
XCEL Energy Services